



Model EX608A11

Hazardous Area Approved Industrial ICP® Accelerometer

Installation and Operating Manual

**For assistance with the operation of this product,
contact PCB Piezotronics, Inc.**

**Toll-free: 800-959-4464
24-hour SensorLine: 716-684-0001
Fax: 716-684-3823
E-mail: imi@pcb.com
Web: www.imi-sensors.com**



The information contained in this document supersedes all similar information that may be found elsewhere in this manual.

Total Customer Satisfaction – PCB Piezotronics guarantees Total Customer Satisfaction. If, at any time, for any reason, you are not completely satisfied with any PCB product, PCB will repair, replace, or exchange it at no charge. You may also choose to have your purchase price refunded in lieu of the repair, replacement, or exchange of the product.

Service – Due to the sophisticated nature of the sensors and associated instrumentation provided by PCB Piezotronics, user servicing or repair is not recommended and, if attempted, may void the factory warranty. Routine maintenance, such as the cleaning of electrical connectors, housings, and mounting surfaces with solutions and techniques that will not harm the physical material of construction, is acceptable. Caution should be observed to insure that liquids are not permitted to migrate into devices that are not hermetically sealed. Such devices should only be wiped with a dampened cloth and never submerged or have liquids poured upon them.

Repair – In the event that equipment becomes damaged or ceases to operate, arrangements should be made to return the equipment to PCB Piezotronics for repair. User servicing or repair is not recommended and, if attempted, may void the factory warranty.

Calibration – Routine calibration of sensors and associated instrumentation is

recommended as this helps build confidence in measurement accuracy and acquired data. Equipment calibration cycles are typically established by the users own quality regimen. When in doubt about a calibration cycle, a good “rule of thumb” is to recalibrate on an annual basis. It is also good practice to recalibrate after exposure to any severe temperature extreme, shock, load, or other environmental influence, or prior to any critical test.

PCB Piezotronics maintains an ISO-9001 certified metrology laboratory and offers calibration services, which are accredited by A2LA to ISO/IEC 17025, with full traceability to N.I.S.T. In addition to the normally supplied calibration, special testing is also available, such as: sensitivity at elevated or cryogenic temperatures, phase response, extended high or low frequency response, extended range, leak testing, hydrostatic pressure testing, and others. For information on standard recalibration services or special testing, contact your local PCB Piezotronics distributor, sales representative, or factory customer service representative.

Returning Equipment – *Following these procedures will insure that your returned materials are handled in the most expedient manner.* Before returning any equipment to PCB Piezotronics, contact your local distributor, sales representative, or factory customer service representative to obtain a Return

Materials Authorization (RMA) Number. This RMA number should be clearly marked on the outside of all package(s) and on the packing list(s) accompanying the shipment. A detailed account of the nature of the problem(s) being experienced with the equipment should also be included inside the package(s) containing any returned materials.

A Purchase Order, included with the returned materials, will expedite the turn-around of serviced equipment. It is recommended to include authorization on the Purchase Order for PCB to proceed with any repairs, as long as they do not exceed 50% of the replacement cost of the returned item(s). PCB will provide a price quotation or replacement recommendation for any item whose repair costs would exceed 50% of replacement cost, or any item that is not economically feasible to repair. For routine calibration services, the Purchase Order should include authorization to proceed and return at current pricing, which can be obtained from a factory customer service representative.

Warranty – All equipment and repair services provided by PCB Piezotronics, Inc. are covered by a limited warranty against defective material and workmanship for a period of one year from date of original purchase. Contact

PCB for a complete statement of our warranty. Expendable items, such as batteries and mounting hardware, are not covered by warranty. Mechanical damage to equipment due to improper use is not covered by warranty. Electronic circuitry failure caused by the introduction of unregulated or improper excitation power or electrostatic discharge is not covered by warranty.

Contact Information – International customers should direct all inquiries to their local distributor or sales office. A complete list of distributors and offices can be found at www.pcb.com. Customers within the United States may contact their local sales representative or a factory customer service representative. A complete list of sales representatives can be found at www.pcb.com. Toll-free telephone numbers for a factory customer service representative, in the division responsible for this product, can be found on the title page at the front of this manual. Our ship to address and general contact numbers are:

PCB Piezotronics, Inc.
3425 Walden Ave.
Depew, NY 14043 USA
Toll-free: (800) 828-8840
24-hour SensorLineSM: (716) 684-0001
Website: www.pcb.com
E-mail: info@pcb.com



INDUSTRIAL MONITORING INSTRUMENTATION DIVISION

SENSORS AND INSTRUMENTATION FOR MACHINE CONDITION MONITORING

Piezoelectric ICP® Accelerometers Operating Guide

Operating Guide with Enclosed Warranty Information

3425 Walden Avenue, Depew, New York 14043-2495

Phone (716) 684-0003

Fax (716) 684-3823

Toll Free Line 1-800-959-4IMI

***MANUAL NUMBER: 18405
MANUAL REVISION: NR***

General OPERATING GUIDE

for use with

PIEZOELECTRIC ICP[®] ACCELEROMETERS

SPECIFICATION SHEET, INSTALLATION DRAWING
AND CALIBRATION INFORMATION ENCLOSED

IMI ASSUMES NO RESPONSIBILITY FOR DAMAGE CAUSED TO THIS PRODUCT AS A RESULT OF PROCEDURES THAT ARE INCONSISTENT WITH THIS OPERATING GUIDE.

1.0 INTRODUCTION

Congratulations on the purchase of a quality industrial ICP[®] sensor. In order to ensure the highest level of performance for this product, it is imperative that you properly familiarize yourself with the correct mounting and installation techniques before attempting to operate this device. If, after reading this manual, you have any additional questions concerning this sensor or its application, feel free to call an Application Engineer at 716-684-0003 or 800-959-4464.

Proper sensor selection requires special attention to three main areas: sensor design, dynamic expectations, and application environment.

Sensor design encompasses the actual sensing element, the physical material, and component selection for the sensor. Preferred industrial accelerometers employ a shear sensing element with either a quartz or ceramic crystal.

Quartz sensing elements are typically used when long-term stability and minimum output shifts due to temperature changes are desired. Ceramic sensing elements provide excellent resolution and durability in noisy environments, and can be designed to supply low-frequency and high-frequency measurements. Shear-design sensors are preferred because of their inherent insensitivity to adverse environmental influences, such as case or base strain and thermal transients. Internal case isolation and shielding is important in avoiding erroneous signals resulting from ground loops and pick-up of electromagnetic and radio frequency interference. Other critical material selection criteria include non-magnetic stainless steel housing, hermetic sealing, and industrial military connectors. See Figure 1.



Figure 1. Typical ICP[®] Industrial Shear Mode Accelerometer

Dynamic expectations are application-specific and refer to the frequency range of measurement and the anticipated amplitudes of vibration. After careful review of the machinery to be monitored, minimum and maximum measurement frequency range may be established. The minimum measurement frequency is normally related to any sub-harmonics of running speed or any lower frequencies where vibration data is to be collected. The maximum measurement frequency of interest is determined by the maximum number of harmonics of an event like running speed, bearing frequencies, or gear mesh. This measurement frequency range should be well within the specified frequency range of the sensor.

Amplitude range refers to the anticipated levels of vibration to be measured. These values are related to the alarm levels set for the machine. By carefully evaluating the idiosyncrasies of the machinery, the predictive maintenance engineer can estimate the minimum expected vibration levels and ensure that the electrical noise floor of the accelerometer is less than those levels.

The environment of the application is a critical consideration during program implementation. The sensor chosen must be capable of surviving the wide range of conditions to which it is subjected; therefore, take time to evaluate potential conditions, such as high temperatures and chemical contaminants. The specified temperature range of the sensor must conform to the fluctuations of the environmental temperature. If harsh industrial chemicals are present, the sensor requires hermetic sealing and construction that resists corrosion. Finally, specific location of the sensor within the environment must be sensible, as both cable and sensor may be damaged by imprudent installation in heavily traveled, physically punishing areas.

2.0 ICP® ACCELEROMETERS

Enclosed in the back of this guide is a **Specification Sheet**, which lists the complete performance characteristics of the particular sensor.

All ICP® sensors require a constant current power source for proper operation. A typical sensing system includes an ICP® sensor, ordinary two conductor cable and a basic constant current power supply (as shown in Figure 2).

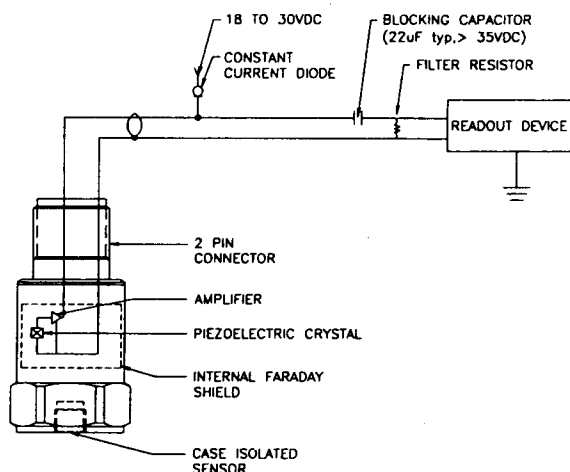

Figure 2. Typical ICP® Sensor System

The signal conditioner consists of a well-regulated 18 to 30 VDC source (battery or line-powered), a current-regulating diode (or equivalent constant current circuit), and a capacitor for decoupling (removing the bias voltage) the signal.

The current-regulating device is used in place of a resistor for several reasons. The very high dynamic resistance of the diode yields a source follower gain

which is extremely close to unity and independent of input voltage. Also, the diode can be changed to supply higher currents for driving long cable lengths. Constant current diodes, as shown in Figure 3, should be used in ICP® signal conditioners. **(The correct orientation of the diode within the circuit is critical for proper operation.)** Except for special models, standard ICP® sensors require a minimum of 2 mA for proper operation.

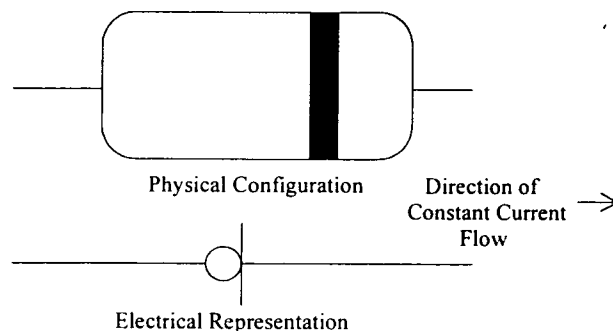

Figure 3. Constant Current Diode

The typical limits for this type of diode are to a 4 mA maximum rating; however, several diodes can be placed in parallel for higher current levels. All line-powered signal conditioners should use higher capacity (up to 20 mA) constant current circuits in place of the diodes, particularly when driving long signal cables (See Section 5).

Decoupling of the data signal occurs at the output stage of the signal conditioner. A 10 to 30 μ F capacitor coupled with a resistor shifts the signal level to essentially eliminate the sensor bias voltage. The result is a drift-free AC mode of operation.

3.0 OPTIONAL FEATURES

In addition to standard features, a variety of options are also available. When listed before the model number, the following prefix letters indicate that the sensor is manufactured or supplied with optional features:

- CS - Canadian Standards Association Approved Sensor
- D - Dummy, non-working sensor for display purposes
- EX - Cenelec Approved Sensor
- FM - Factory Mutual Approved Sensor
- HT - High Temperature accelerometer (325 °F)
- LB - Low Bias electronics
- LC - Limited Calibration (one point calibration)
- LP - Low Pass filter
- M - Metric mounting hardware and cable length
- U - Usable demonstration sensor (does not meet one or more minor specifications)
- VO - Velocity Output Sensors

MS - Mine Safety Approved Sensors
 TO - Temperature Output Sensor

Note: *Not all sensors are available with the optional prefixes. Contact the factory to discuss special features that may be needed.*

4.0 INSTALLATION OVERVIEW

When choosing a mounting method, consider closely both the advantages and disadvantages of each technique. Characteristics like location, ruggedness, amplitude range, accessibility, temperature, and portability are extremely critical. However, the most important and often overlooked consideration is the effect the mounting technique has on the high-frequency operating range of the accelerometer.

Shown in Figure 4 are six possible mounting techniques and their effects on the performance of a typical piezoelectric accelerometer. (Note: *Not all of the mounting methods may apply to your particular sensor.*) The mounting configurations and corresponding graph demonstrate how the high-frequency response of the accelerometer may be compromised as mass is added to the system and/or the mounting stiffness is reduced.

Note: *The low-frequency response is unaffected by the mounting technique. This roll-off behavior is typically fixed by the sensor's built-in electronics. However, when operating AC-coupled signal conditioners with readout devices having an input impedance of less than one megaohm, the low frequency range may be affected.*

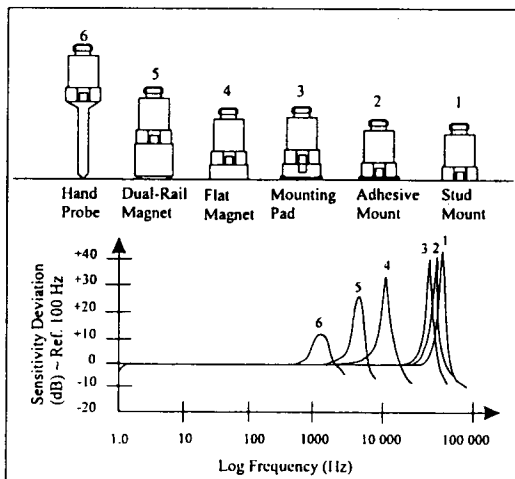

Figure 4. Assorted Mounting Configurations and Their Effects on High Frequency

4.1 STANDARD STUD MOUNT

This mounting technique requires smooth, flat contact surfaces for proper operation and is recommended for permanent and/or secure installations. Stud mounting is also recommended when testing at high frequencies.

Note: *Do NOT attempt mounting on curved, rough, or uneven surfaces, as the potential for misalignment and limited contact surface may significantly reduce the sensor's upper operating frequency range.*

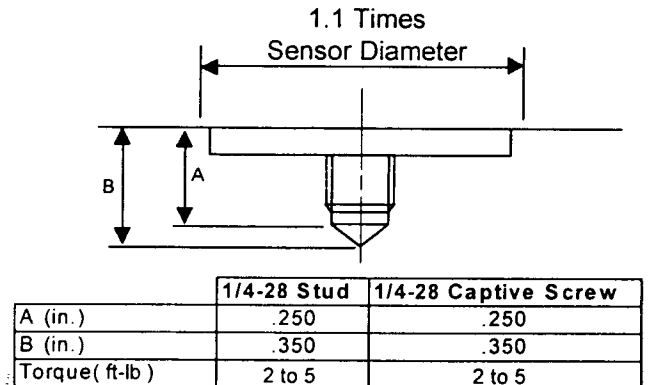

Figure 5. Mounting Surface Preparation

STEP 1: First, prepare a smooth, flat mounting surface, and then drill and tap a mounting hole in the center of this area as shown in Figure 5.

A precision-machined mounting surface with a minimum finish of 63 μin (0,00016 mm) is recommended. (If it is not possible to properly prepare the machine surface, consider using an adhesive mounting pad as a possible alternative.) Inspect the area, checking that there are no burrs or other foreign particles interfering with the contact surface.

STEP 2: Wipe clean the mounting surface and spread on a light film of grease, oil, or similar coupling fluid prior to installation.

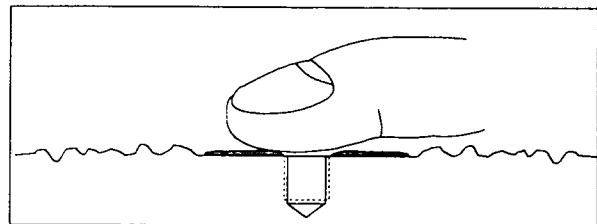

Figure 6. Mounting Surface Lubrication

Adding a coupling fluid improves vibration transmissibility by filling small voids in the mounting surface and increasing the mounting stiffness. For semi-

permanent mounting, substitute epoxy or another type of adhesive.

STEP 3: Hand-tighten the sensor/mounting stud to the machine, then secure the sensor with a torque wrench to the mounting surface by applying the recommended mounting torque (see enclosed specification data sheet for proper mounting torque).

It is important to use a torque wrench during this step. Under-torquing the sensor may not adequately couple the device; over-torquing may result in stud failure and possibly permanent damage.

4.2 ADHESIVE MOUNT

Adhesive mounting is often used for temporary installation or when the machine surface cannot be adequately prepared for stud mounting. Adhesives like hot glue or wax work well for temporary mounts; two-part epoxies and quick-bonding gels provide a more permanent mount.

Note: Adhesively-mounted sensors often exhibit a reduction in high-frequency range. Generally, smooth surfaces and stiff adhesives provide the best frequency response. Contact the factory for recommended epoxies.

METHOD 1 - Adhesive Mounting Base

This method involves attaching a base to the machine surface, then securing the sensor to the base. This allows for easy removal of the accelerometer.

STEP 1: Prepare a smooth, flat mounting surface. A minimum surface finish of 63 μin (0,00016 mm) generally works best.

STEP 2: Stud-mount the sensor to the appropriate adhesive mounting base according to the guidelines set forth in **STEPS 2** and **3** of the Stud Mount Procedure.

STEP 3: Place a small portion of adhesive on the underside of the mounting base. Firmly press down on the assembly to displace any extra adhesive remaining under the base.



Figure 7. Mounting Base: Adhesive Installation

METHOD 2 - Direct Adhesive Mount

For restrictions of space or for convenience, most sensors (with the exception of integral stud models) can be adhesive-mounted directly to the machine surface.

STEP 1: Prepare a smooth, flat mounting surface. A minimum surface finish of 63 μin (0,00016 mm) generally works best.

STEP 2: Place a small portion of adhesive on the underside of the sensor. Firmly press down on the top of the assembly to displace any adhesive. Be aware that excessive amounts of adhesive can make sensor removal difficult.

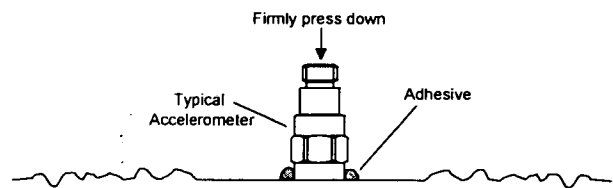

Figure 8. Direct Adhesive Mounting

4.3 MAGNETIC MOUNT

Magnetic mounting provides a convenient means for making portable measurements and is commonly used for machinery monitoring and other portable or trending applications.

Note: The correct magnet choice and an adequately prepared mounting surface is critical for obtaining reliable measurements, especially at high frequencies. Poor installations can cause as much as a 50% drop in the sensor frequency range.

Not every magnet is suitable for all applications. For example, rare earth magnets are commonly used because of their high strength. Flat magnets work well on smooth, flat surfaces, while dual-rail magnets are required for curved surfaces. In the case of non-magnetic or rough surfaces, it is recommended that the user first weld, epoxy, or otherwise adhere a steel mounting pad to the test surface. This provides a smooth and repeatable location for mounting.

STEP 1: After choosing the correct magnet type, inspect the unit, verifying that the mounting surfaces are flat and smooth.



Figure 9. Magnet Types

STEP 2: Stud-mount the accelerometer to the appropriate magnet according to the guidelines set forth in STEPS 2 and 3 of the Stud Mount Procedure.

STEP 3: Prepare a smooth, flat mounting surface. A minimum surface finish of 63 μm (0,00016 mm) generally works best. After cleaning the surface and checking for burrs, wipe on a light film of silicone grease, machine oil, or similar-type coupling fluid.

STEP 4: Mount the magnet/sensor assembly to the prepared test surface by gently “rocking” or “sliding” it into place.

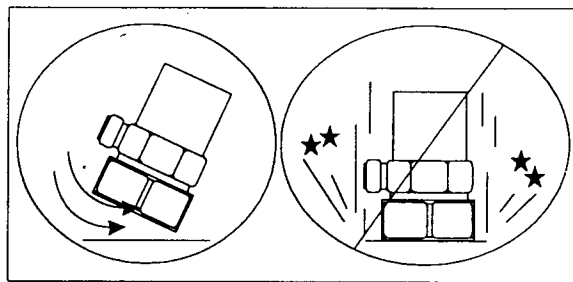

Figure 10. Magnet Mounting

Note: *Magnetically mounting accelerometers carelessly has the potential to generate very high (and very damaging) g levels. To prevent damage, install the assembly gently. If unsure, please contact the factory for assistance.*

4.4 HANDHELD OR PROBE TIP MOUNT

This method is NOT recommended for most applications. It is generally used where access to machinery may be a safety concern. Both the accuracy and repeatability at low (<5 Hz) and high frequency (>1 kHz) ranges are questionable.

5.0 CABLING

The selection of connectors and cables has a direct impact on the ruggedness and reliability of the sensor installation. A consideration when dealing with cables is the way in which the cable conductors are terminated.

ICP[®] accelerometers are internally amplified, two-wire accelerometers. Connections to the sensor requires two leads: one for the power and signal, and the other for the common and signal return. Often, coaxial cables are used since only two conductors are needed. Coaxial cables are less expensive. With coaxial cables, however, erroneous signals can be introduced into sensor systems through ground loops, electromagnetic interference, or radio frequency interference (EMI or RFI). To avoid ground loops, there should only be one ground in the system.

It is recommended for permanent installations that the sensor be case-isolated and internally shielded with a dual-case design and use a two-conductor shielded cables to insure clean vibration signal transmission. Two-conductor shielded cables allow the signal and the signal return (common) to be fully shielded from the sensor to the readout equipment. To insure that ground loop signals are not induced, the shield should only be terminated at one end. Typically, the shield of a two-conductor shielded cable is left open or not connected at the sensor end and is tied to earth ground at the instrumentation end.

Operation over long cables may affect the frequency response of ICP[®] accelerometers, and introduce low frequency noise and high frequency distortion when an insufficient current is available to drive cable capacitance.

Unlike charge mode systems, where the system noise is a function of cable length, ICP[®] sensors provide a high voltage, low impedance output well-suited for driving long cables through harsh environments. While there is virtually no increase in noise with ICP[®] sensors, the capacitive loading of the longer cable may distort or filter higher frequency signals depending on the supply current and the output impedance of the sensor.

Generally, this signal distortion is not a problem with lower frequency testing within a range up to 1,000 Hz. However, when monitoring higher frequency vibrations traveling over cables longer than 500 ft., the possibility of signal distortion exists.

The maximum frequency that can be transmitted over a given cable length is a function of both the cable capacitance and the ratio of the peak signal voltage to the current available from the signal conditioner according to:

$$f_{\text{max}} = 10^9 / (2\pi CV / [L_c - 1]) \quad (\text{Equation 1})$$

where, f_{max} = maximum frequency (hertz)

C = cable capacitance (picofarads)
 V = maximum peak output from sensor (volts)
 I_c = constant current from signal
 conditioner (mA)
 10^9 = scaling factor to equate units

Note that in this equation, 1 mA is subtracted from the total current supplied to sensor (I_c). This is done to compensate for powering the internal electronics. Also, note that these are typical values only.

When driving long cables, Equation 1 shows that as the length of cable, peak voltage output or maximum frequency of interest increases, a greater constant current will be required to drive the signal.

The nomograph on page 11 of this manual provides a simple, graphical method for obtaining the expected maximum frequency capability of an ICP® measurement system. The maximum peak signal voltage amplitude, cable capacitance and supplied constant current must be known or presumed.

For example, when running a 100 ft. (30.5 m.) cable with a capacitance of 30 pF/ft, the total capacitance is 3,000 pF. This value can be found along the diagonal cable capacitance lines. Assuming the sensor operates at a maximum output range of 5 volts and the constant current available from the power supply is 2 mA, the ratio on the vertical axis can be calculated to equal 5. The intersection of the total cable capacitance and this ratio result in a maximum frequency of approximately 10.2 kHz.

The nomograph does not indicate whether the frequency amplitude response at a point is flat, rising or falling. For precautionary reasons, it is good general practice to increase the constant current (if possible) to the sensor (within its maximum limit) so that the frequency determined from the nomograph is approximately 1.5 to 2 times greater than the maximum frequency of interest.

Note: Higher current levels will deplete battery-powered signal conditioners at a faster rate. Also, any current not used by the cable goes directly to power the internal electronics and will create heat. This may cause the sensor to exceed its maximum temperature specification. For this reason, do not supply excessive current over short cable runs or when testing at elevated temperatures.

5.1 CABLE CONNECTOR PROCEDURE

Care and attention to installation is essential, as the reliability and accuracy of your system is no better than that of the output cable.

STEP 1: Ascertain that you have ordered the correct cable type.

As with sensors, no cable can satisfy all applications. Special low-noise cabling should be used with high-impedance, charge-output devices. ICP® sensors usually operate with any ordinary two-wire cable. Industrial applications often require twisted/shielded cables to reduce the effects of EMI and RFI. Teflon-jacketed cabling may be necessary to withstand corrosive environments.

STEP 2: Connect the cable to the accelerometer. A small amount of thread-locking compound placed on the connector prior to attachment helps secure the cable during testing. In harsh environments, the connection can be sealed with silicon rubber, O-rings, and flexible heat-shrink tubing.

STEP 3: Plug the connector of the cable into the mating sensor connector. Then, holding the sensor stationary, secure the connector in place by tightening down the attached threaded cable sleeve.

STEP 4: Route the cable to the signal conditioner, making certain to stress-relieve the sensor/cable connection and minimize motion by clamping the cable at regular intervals.

Common sense should be used to avoid physical damage and minimize electrical noise. For instance, avoid routing cables near high-voltage wires. Do not route cables along floors or walkways where they may be stepped on or become contaminated. Shielded cables should have the shield grounded at one end only, normally at the instrumentation end.

STEP 5: Finally, connect the remaining cable end to the signal conditioner or readout device. To dissipate charge that may have accumulated in the cable, short the signal to the ground prior to attachment.

6.0 POWERING

All ICP® sensors require constant current excitation for proper operation. For this reason, use only IMI constant-current signal conditioners or other approved constant-current sources. A typical system schematic is shown in Figure 11.

Note: Damage to the built-in electronics resulting from the application of incorrect power or the use of an unapproved power source is NOT covered by warranty.



Figure 11. Typical System Schematic

The power supply consists of a regulated 18 to 30 VDC source. In general, battery-powered devices offer versatility for portable, low-noise measurements, whereas line-powered units provide the capability for continuous monitoring. This power is regulated by a current-limiting circuit, which provides the constant-current excitation required for proper operation of ICP[®] sensors.

Note: Under no circumstances should a voltage be supplied to an ICP[®] accelerometer without a current-regulating diode or equivalent electrical circuit.

Meters or LEDs are used to monitor the bias voltage on the sensor output signal to check sensor operation and detect cable faults. Normally, a "yellow" reading indicates an open circuit; "green" indicates normal operation; and "red" indicates either a short or low bias condition. Finally, a capacitor at the output stage of the device removes the sensor output bias voltage from the measurement signal. This provides a zero-based, AC-coupled output compatible with most standard readout devices.

Note: Low bias units may be in the "red," when actually they are working properly. Check bias digitally with a multimeter.

Today, many FFT analyzers, data acquisition modules, and data collectors have constant-current excitation for direct use with ICP[®] sensors. However, before using this feature, check that the supply voltage and constant current are adequate for use with your sensor. (Check enclosed **Specification Sheet**.) Please contact the respective Signal Conditioner Manufacturer or check the product manual for more information.

7.0 OPERATING

After completing the system setup, switch on the conditioner and allow the sensor to power up. If using an IMI battery-powered signal conditioner, the meter (or LED) on the signal conditioner should be reading "green." This indicates proper operation, and the user may begin taking measurements. If a faulty condition is

monitored, first check all system connections, then check the functionality of the cable and signal conditioner. If the system still does not operate properly, consult an IMI Application Engineer.

Note: Always operate the accelerometer within the limitations listed on the enclosed **Specification Sheet**. Operating the device outside these parameters can cause temporary or permanent damage to the sensor.

8.0 ACCELEROMETER CALIBRATION

Note: It is good measurement practice to verify the performance of each accelerometer with a Handheld Shaker or other calibration device before and after each measurement. The IMI Handheld Shaker operates at a fixed frequency and known amplitude (1.0 g) to provide a quick check of sensor sensitivity.

Accelerometers are precision measuring instruments. They are highly engineered to provide accurate electrical signals representative of the vibration being monitored. Each sensor is calibrated by comparison to a known acceleration level. Some calibrations include frequency response curves, resonant frequency measurements, transverse sensitivity, and many other valuable tests. Applications requiring a high degree of accuracy or those in plants requiring certification and traceability require full calibration test results. Figure 12 shows a typical calibration data sheet.

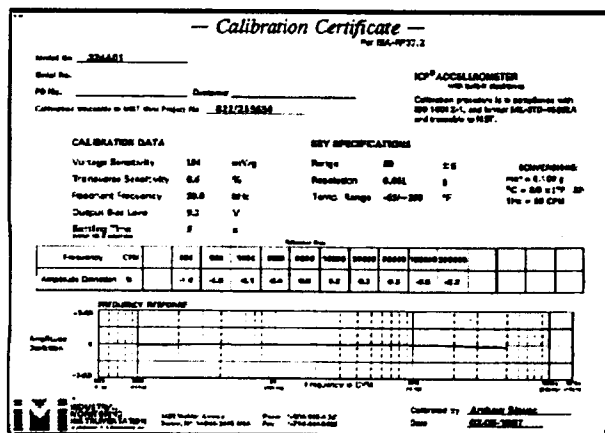

Figure 12. Typical Calibration Certificate

Some applications have much less stringent requirements for calibration certification. Simple sensitivity measurements at a single frequency may be sufficient; operational verification and certificates of conformance to published specifications may satisfy many plants' calibration needs. Reducing the final calibration requirements reduces the cost of manufacturing the sensor and should lower the price for predictive maintenance users.

Periodic recalibration may be required by plants with strict certification and traceability requirements. It is always recommended that the user has the sensor recalibrated periodically, particularly if the sensor has experienced a very high shock level or extreme temperatures for extended periods of time. Some plants develop in-house calibration capabilities for periodically verifying the performance of accelerometers. Products are available that provide a set 1g-acceleration level at a fixed frequency for quick sensor checking.

For these reasons, it is recommended that a recalibration cycle be established for each accelerometer. This schedule is unique and is based on a variety of factors, such as extent of use, environmental conditions, accuracy requirements, trend information obtained from previous calibration records, contractual regulations, frequency of "cross-checking" against other equipment, manufacturer recommendation, and any risk associated with incorrect readings. International standards, such as ISO 10012-1, provide insight and suggested methods for determining recalibration intervals for most measuring equipment. With the above information in mind and under "normal" circumstances, IMI conservatively suggests a 12- to 24-month recalibration cycle for most piezoelectric accelerometers.

8.1 SENSOR RECALIBRATION

Accelerometer recalibration services are typically performed by IMI's internal metrology laboratory. (Other international and private laboratories are also available.) The IMI laboratory is certified to ISO 9001, complies with ISO 10012-1 (and former MIL-STD-45662A), and uses equipment directly traceable to NIST. This assures an accurate calibration of relevant specifications.

The following includes a broad overview of the Back-to-Back Calibration technique normally used when calibrating accelerometers. This technique provides a quick and easy method for determining the sensitivity of a test accelerometer over a wide frequency range.

8.2 BACK-TO-BACK CALIBRATION THEORY

Back-to-Back Calibration is perhaps the most common method for determining the sensitivity of piezoelectric accelerometers. This method relies on a simple comparison to a previously calibrated accelerometer, typically referred to as a reference standard, as shown in Figure 13.



Figure 13. Reference Standard Accelerometer

These high-accuracy devices, which are directly traceable to a recognized standards laboratory, are designed for stability, as well as configured to accept a test accelerometer. By mounting a test accelerometer to the reference standard and then connecting this combination to a suitable vibration source, it is possible to vibrate both devices and compare the data as shown in Figure 14. (Test set-ups may be automated and vary, depending on the type and number of accelerometers being calibrated.)



Figure 14. Typical Back-to-Back Calibration System

Because the acceleration is the same on both sensors, the ratio of their outputs (V_T/V_R) must also be the ratio of their sensitivities. With the sensitivity of the reference standard (S_R) known, the exact sensitivity of the test sensor (S_T) is easily calculated by using the following equation:

$$S_T = S_R (V_T/V_R)$$

By varying the frequency of the vibration, the sensor may be calibrated over its entire operating frequency range. The typical response of an unfiltered accelerometer is shown in Figure 15.



Figure 15. Typical Test Accelerometer Response

9.0 TROUBLESHOOTING

Piezoelectric sensors are dynamic measuring equipment. They use piezoelectric sensing elements to convert or transduce the mechanical phenomena to an electrical signal. The mechanical parameter may be force, pressure, or vibration. The raw electrical signal from a piezoelectric charge element is a high impedance signal. This charge signal is normally converted to a low impedance voltage signal by either an external charge amplifier or an external voltage amplifier. The cables between the charge sensor and the amplifier must be high quality, low noise cable and must be kept as short as possible. Figure 16 shows a typical high impedance system.



Figure 16. High Impedance System Connection

Internally amplified sensors, or ICP[®] sensors, employ miniature amplifiers to convert the high impedance charge signal into a low impedance voltage signal. These amplifiers are internal to the sensor, and therefore, do not require low noise cables or external amplifiers. These amplifiers have set gain so that output sensitivities are standardized.



Figure 17. ICP[®] Sensor System Connector

ICP[®] sensors are two-wire sensors. They are powered with a constant current DC source. The power supply is typically 18 to 30 volts DC current limited via a constant current between 2 and 20 mA. Typical battery operated supplies offer 2 mA of constant current to extend battery life while continuous monitoring systems offer more

current in order to drive longer cables. Figure 17 shows a typical ICP[®] sensor system.

The signal output of an ICP[®] sensor is a low impedance voltage signal proportional to the dynamic measurement such as force, pressure, or vibration. This voltage signal is carried on a DC bias voltage. The AC dynamic signal is superimposed on the DC bias voltage and is allowed to swing between the supply voltage and ground as shown in Figure 18. Unlike an operational amplifier (Op Amp) that requires a plus and minus supply and allows the signal to "ride" on ground and "swing" between the plus and minus "rails," the ICP[®] sensor requires the output signal to be DC biased.

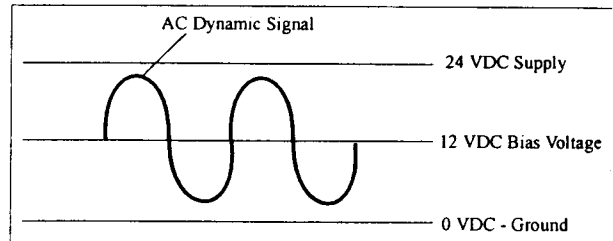

Figure 18. Sensor DC Bias Voltage

This DC bias voltage is an excellent diagnostic tool. The voltage provides a means of verifying that the amplifier is "turned on." Typical input/output power supplies will block this DC bias voltage at the output via a blocking capacitor in order to AC couple the signal to readout devices. By "teeing" off the input into a DC volt meter, as shown in Figure 19, the bias voltage can be measured.

While measuring the supply voltage, the bias voltage can be measured after the sensor is plugged in. If the meter stays at supply, something in the system is open or not connected. If the meter reads "0," something in the system is shorted. If the meter reads within the bias voltage range of the sensor, then the sensor and cabling are functioning properly.

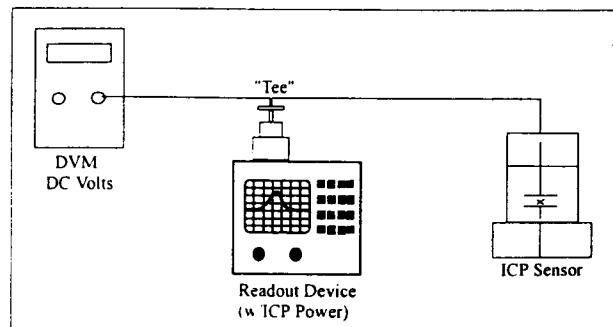

Figure 19. DC Bias Voltage Measurement

10.0 REPAIR/RETURN PROCEDURE

Because of the nature of most IMI instrumentation, field repair is typically NOT recommended and may void any warranty. If factory service is required, contact IMI for a **RETURN MATERIAL AUTHORIZATION (RMA)** number prior to sending equipment to the factory. Please have information available, such as model and serial number. Also, to insure efficient service, be sure to include a written description of the symptoms and problems with the equipment to a local sales representative or distributor, or contact IMI if none are located in your area.

Customers outside the U.S. should consult their local IMI distributor for information on returning equipment. For exceptions, please contact the International Sales department at IMI to request shipping instructions and an RMA. For assistance, please call (716) 684-0003, or fax us at (716) 684-3823. You may also receive assistance via e-mail at imi@pcb.com or visit our web site at www.pcb.com.

11.0 CUSTOMER SERVICE / WARRANTY

IMI, a division of PCB Piezotronics, guarantees Total Customer Satisfaction. If, at any time, for any reason, you are not completely satisfied with any IMI product, IMI will repair, replace, or exchange it at no charge. You may also choose, within the warranty period, to have your purchase price refunded.

IMI instrumentation is warranted against defective material and workmanship for one year unless otherwise expressly specified. Damage to instruments caused by incorrect power or misapplication is not covered by warranty. If there are any questions regarding power, intended application, or general usage, please consult with your local sales contact or distributor. Batteries and other expendable hardware items are not covered by warranty.

IMI offers to all customers, at no charge, 24-hour phone support. This service makes product or application support available to our customers, day or night, seven days a week. When unforeseen problems or emergency situations arise, call the **IMI Hot Line at 716-684-0003**, and an application specialist will assist you.



3425 Walden Avenue, Depew, NY 14043

Phone: 716-684-0003 • USA Fax: 716-684-3823 • INTL. Fax: 716-684-4703

ICP® is a registered trademark of PCB Piezotronics, Inc., which uniquely identifies PCB sensors that incorporate built-in microelectronics.

Cable Driving Nomograph



Model Number
608A11

INDUSTRIAL ICP® ACCELEROMETER

Revision: H
ECN #: 28546

Performance	ENGLISH	SI	
Sensitivity(± 15 %)	100 mV/g	10.2 mV/(m/s ²)	[2]
Measurement Range	± 50 g	± 490 m/s ²	
Frequency Range(± 3 dB)	30 to 600,000 cpm	0.5 to 10,000 Hz	
Resonant Frequency	1320 kcpm	22 kHz	[1]
Broadband Resolution(1 to 10,000 Hz)	350 µg	3434 µm/s ²	[1]
Non-Linearity	± 1 %	± 1 %	[3]
Transverse Sensitivity	≤ 7 %	≤ 7 %	
Environmental			
Overload Limit(Shock)	5000 g pk	49,050 m/s ² pk	
Temperature Range	-65 to +250 °F	-54 to +121 °C	
Temperature Response	See Graph	See Graph	[1]
Enclosure Rating	IP68	IP68	
Electrical			
Settling Time(within 1% of bias)	≤ 2.0 sec	≤ 2.0 sec	
Discharge Time Constant	≥ 0.3 sec	≥ 0.3 sec	
Excitation Voltage	18 to 28 VDC	18 to 28 VDC	
Constant Current Excitation	2 to 20 mA	2 to 20 mA	
Output Impedance	<150 ohm	<150 ohm	
Output Bias Voltage	8 to 12 VDC	8 to 12 VDC	
Spectral Noise(10 Hz)	8 µg/√Hz	78.5 (µm/s ²)/√Hz	[1]
Spectral Noise(100 Hz)	5 µg/√Hz	49.1 (µm/s ²)/√Hz	[1]
Spectral Noise(1 kHz)	4 µg/√Hz	39.2 (µm/s ²)/√Hz	[1]
Electrical Isolation(Case)	>10 ⁸ ohm	>10 ⁸ ohm	
Physical			
Size (Hex x Height)	9/16 in x 2.5 in	14 mm x 64 mm	
Weight(with cable)	3.5 oz	99.3 gm	
Mounting	Stud	Stud	
Mounting Thread	1/4-28 Female	1/4-28 Female	[4]
Mounting Torque	2 to 5 ft-lb	2.7 to 6.8 N-m	
Sensing Element	Ceramic	Ceramic	
Sensing Geometry	Shear	Shear	
Housing Material	Stainless Steel	Stainless Steel	
Sealing	Molded	Molded	
Electrical Connector	Molded Integral Cable	Molded Integral Cable	
Electrical Connection Position	Top	Top	
Cable Length	10 ft	3 m	
Cable Type	Polyurethane	Polyurethane	[5]

OPTIONAL VERSIONS
Optional versions have identical specifications and accessories as listed for the standard model except where noted below. More than one option may be used.

EX - ATEX or ATEX and CSA Hazardous Area Approval		
Hazardous Area Approval	EEx nL IIC T4, -40°C≤Tas 121°C, II 3 G	EEx nL IIC T4, -40°C≤Tas 121°C, II 3 G
Hazardous Area Approval	EEx nL IIC T4, -40°C≤Tas 121°C, II 1 G	EEx nL IIC T4, -40°C≤Tas 121°C, II 1 G
Hazardous Area Approval	CI I, Div I, Groups A, B, C, D; CI II, Div I, Groups E, F, G; CI III, Div I	CI I, Div I, Groups A, B, C, D; CI II, Div I, Groups E, F, G; CI III, Div I
Hazardous Area Approval	CI I, Div 2, Groups A, B, C, D; ExnL IIC T4, AExnA IIC T4	CI I, Div 2, Groups A, B, C, D; ExnL IIC T4, AExnA IIC T4
Hazardous Area Approval	Exia IIC T4, AExia IIC, T4	Exia IIC T4, AExia IIC, T4

LB - Low Bias Voltage		
Output Bias Voltage	4.8 to 6.5 VDC	4.8 to 6.5 VDC
Excitation Voltage	12 to 28 VDC	12 to 28 VDC
Measurement Range	± 10 g	± 98 m/s ²

M - Metric Mount
Supplied Accessory : Model M081A61 Mounting Stud 1/4-28 to M6 X 1 (1) replaces Model 081A40

TO - Temperature Output		
Temperature Output Range	+36 to +250 °F	+2 to +121 °C
Temperature Scale Factor	5.56 mV/°F + 32	+10 mV/°C
Electrical Connector	Molded Integral Cable	Molded Integral Cable
Electrical Connections(Red)	Acceleration Output	Acceleration Output
Electrical Connections(Black)	Ground	Ground
Electrical Connections(White)	Temperature Output	Temperature Output

NOTES:
[1] Typical.
[2] Conversion Factor 1g = 9.81 m/s².
[3] Zero-based, least-squares, straight line method.
[4] 1/4-28 has no equivalent in S.I. units.
[5] Twisted shielded pair.
[6] See PCB Declaration of Conformance PS023 or PS060 for details.

SUPPLIED ACCESSORIES:
Model 081A40 Mounting Stud (1)
Model ICS-2 NIST-traceable single-axis single-point amplitude response calibration at 6000 cpm (100 Hz) (1)

Entered: <i>LU</i>	Engineer: <i>LAB</i>	Sales: <i>EGY</i>	Approved: <i>EB</i>	Spec Number:
Date: <i>4-7-08</i>	Date: <i>4-1-08</i>	Date: <i>4-3-08</i>	Date: <i>4-4-08</i>	13273

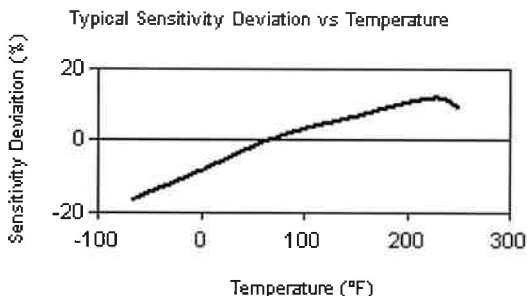

[6]



All specifications are at room temperature unless otherwise specified.
In the interest of constant product improvement, we reserve the right to change specifications without notice.
ICP® is a registered trademark of PCB Group, Inc.

IMI SENSORS
A PCB PIEZOTRONICS DIV.
3425 Walden Avenue, Depew, NY 14043

Phone: 800-959-4464
Fax: 716-684-3823
E-Mail: imi@pcb.com

ATEX Approved Sensors Vibration Sensors (ICP®)

English

This sensor has been approved for Hazardous Locations Directive 94/9/EC, Ex ia IIC T4 and Ex nL IIC T4.

For safe use:

- All applicable local electrical laws must be followed
- The supply electrical parameters must not exceed any of the following values:
 - o $U_0 \leq 28V$, $I_0 \leq 200mA$, $P_0 \leq 1W$
- Ambient operating temperature range:
 - o $-40^{\circ}C$ to $+121^{\circ}C$
- For Ex ia IIC T4 installations, the apparatus must only be connected to a certified associated intrinsically safe equipment and this combination must be compatible as regards intrinsic safety rules.

Deutsch

Dieser ist genehmigt worden für Gefährliche Orte Direktive 94/9/EC, Ex ia IIC T4 und Ex nL IIC T4.

- Alle zutreffenden örtlichen elektrischen Gesetze müssen gefolgt werden
- Die Versorgung elektrische Parameter müssen kein von den Folgenden Werten überschreiten:
 - o $U_0 \leq 28V$, $I_0 \leq 200mA$, $P_0 \leq 1W$
- Umgebungsbedienungs-temperaturbereich:
 - o $-40^{\circ}C$ to $+121^{\circ}C$
- Für Ex ia IIC T4 Installationen muss der Apparat nur zu einen bescheinigten verbundenen inner sicheren Ausrüstungen verbunden werden und diese Kombination muss vereinbar sein, während innere Sicherheitsregeln betrachtet.

Français

Ce détecteur a été approuvé pour les Emplacements Hasardeux Directif 94/9/EC, Ex ia IIC T4 et Ex nL IIC T4.

Pour l'usage sûr :

- Toutes lois électriques, locales et applicables doivent être suivies
- La provision les paramètres électriques ne doivent pas dépasser n'importe quel des valeurs suivantes :
 - o $U_0 \leq 28V$, $I_0 \leq 200mA$, $P_0 \leq 1W$
- La gamme de température d'opération Ambiante :
 - o $-40^{\circ}C$ to $+121^{\circ}C$
- Pour les installations de Ex ia IIC T4, l'appareil doit être seulement connecté à un équipement intrinsèquement sûr, associé et certifié et cette combinaison doit être compatible comme considère des mesures de sécurité intrinsèques.

Italiano

Questo sensore è stato approvato per le Posizioni Pericolose Direttivo 94/9/EC, Ex ia IIC T4 ed Ex nL IIC T4.

Per l'uso sicuro:

- Tutte le leggi applicabili, locali elettriche devono essere seguite
- La provvista i parametri elettrici non devono eccedere qualunque dei valori seguenti: seguenti:
 - o $U_0 \leq 28V$, $I_0 \leq 200mA$, $P_0 \leq 1W$
- la gamma di temperatura di funzionamento di Ambiente:
 - o $-40^{\circ}C$ to $+121^{\circ}C$
- Per le installazioni di Ex ia IIC T4, il dispositivo deve essere soltanto collegato a un'apparecchiatura certificata, associata intrinsecamente sicura e questa combinazione deve essere compatibile considera come le regole di sicurezza intrinseche.

Español

Este sensor se ha aprobado para Ubicaciones Peligrosas Directivas 94/9/EC, Ex ia IIC T4 y Ex nL IIC T4.

Para el uso seguro:

- Todas leyes eléctricas, locales y aplicables se deben seguir
- El suministro los parámetros eléctricos no deben exceder cualquiera de los siguientes valores:
 - o $U_0 \leq 28V$, $I_0 \leq 200mA$, $P_0 \leq 1W$
- El Ambiente que opera la gama de la temperatura:
 - o $-40^{\circ}C$ to $+121^{\circ}C$
- Para instalaciones de Ex ia IIC T4, el aparato sólo debe ser conectado a un equipo intrínsecamente seguro, asociado y certificado y esta combinación debe ser compatible considera como las reglas intrínsecas de la seguridad.

Drawing Number: 41721
Revision: NR
Ecn Number:

Русский

Этот датчик был одобрен для Опасной Директивы 94/9/ЕС Местоположений, Ex ia IIC T4 и Ex nL IIC T4.

Для безопасного использования:

- Все применимые местные электрические законы должны сопровождаться
- Поставка электрические параметры не должна превысить ни одной из следующих ценностей:
 - o $U_0 \leq 28V$, $I_0 \leq 200mA$, $P_0 \leq 1W$
- Окружающий операционный температурный диапазон:
 - o $-40^{\circ}C$ to $+121^{\circ}C$
- Поскольку Ex ia IIC T4 сооружения, аппарат должен только быть связан с гарантированным связанным свойственно безопасным оборудованием, и эта комбинация должна быть совместимой, что касается свойственных правил безопасности.

Norsk

Denne sensoren godkjenner for Farlige Plasseringer Direktiv 94/9/EC, Ex ia IIC T4 og Ex nL IIC T4.

For sikker bruk:

- Alle anvendelige lokale elektriske lover fulgt
- Forsyningen elektriske parametre må ikke overskride noe av de følgende verdiene:
 - o $U_0 \leq 28V$, $I_0 \leq 200mA$, $P_0 \leq 1W$
- Omgivende betjeningsav temperaturrekkevidde:
 - o $-40^{\circ}C$ to $+121^{\circ}C$
- For Ex ia IIC T4 installasjoner, apparatet bare bli koplet til et sertifisert tilknyttet indre sikkert utstyr og denne kombinasjonen må være forenelig med hensyn til indre sikkerhetsregel.

Nederlands

Deze sensor is voor Gevaarlijke Locaties Leidinggevende 94/9/EC, Ex ia IIC T4 en Ex nL IIC T4 goedgekeurd worden.

Voor veilige gebruik:

- Alle toepasbare plaatselijke elektrische wetten moeten gevolgd worden
- De aanbod elektrische parameters moeten de volgende waarde niet overschrijden:
 - o $U_0 \leq 28V$, $I_0 \leq 200mA$, $P_0 \leq 1W$
- Het omgevend bediening temperatuur bereik:
 - o $-40^{\circ}C$ to $+121^{\circ}C$
- Voor Ex ia IIC T4 installaties, moet het apparaat enkel aan een gecertificeerde geassocieerde intrinsiek veilige uitrusting worden aangesloten en deze combinatie moet compatibel zijn als intrinsieke veiligheidsregels beschouwt.

Português

Este sensor foi aprovado para a Diretiva 94/9/EC de Posições Arriscada, Ex ia IIC T4 e Ex nL IIC T4.

Para uso seguro:

- Todas as leis elétricas locais aplicáveis devem ser seguidas
- O estoque parâmetros elétricos não devem exceder qualquer dos seguintes valores:
 - o $U_0 \leq 28V$, $I_0 \leq 200mA$, $P_0 \leq 1W$
- Variedade de temperatura operacional ambiente:
 - o $-40^{\circ}C$ to $+121^{\circ}C$
- Para instalações Ex ia IIC T4, o aparelho só deve ser ligado a um associado equipamento seguro certificado, intrinsecamente e esta combinação deve ser compatível como considera regras intrínsecas de segurança.

Svensk

Den här sensoren er blitt gillat för Riskabel Lokaliseringarna Direktiv 94/9/ EC Ex ia IIC T4 och Ex nL IIC T4.

För kassaskåp använda :

- All användbar lokal elektrisk lag måste bli följde efter
- Tillförselen som elektriska parametrar inte måste överskrida några av värderar efter:
 - o $U_0 \leq 28V$, $I_0 \leq 200mA$, $P_0 \leq 1W$
- Omgivande opera- temperatur ställa i rad :
 - o $-40^{\circ}C$ to $+121^{\circ}C$
- För installationer Ex ia IIC T4 måste apparaturen endast förbindas till en tillhörande i sitt innersta väsen kassaskåputrustning för auktoriserad revisor, och denna kombination måste vara kompatibel, som hälsningar inneboende säkerhet härskar.

Drawing Number: 41721
Revision: NR
Ecn Number:

12013

PCB Piezotronics Inc. claims proprietary rights in the information disclosed hereon. Neither it nor any reproduction thereof will be disclosed to others without the written consent of PCB Piezotronics Inc.

REVISIONS

REV	DESCRIPTION	ECO
A	UPDATE FOR UNIFORMITY	13113
B	UPDATE DRAWING	31162

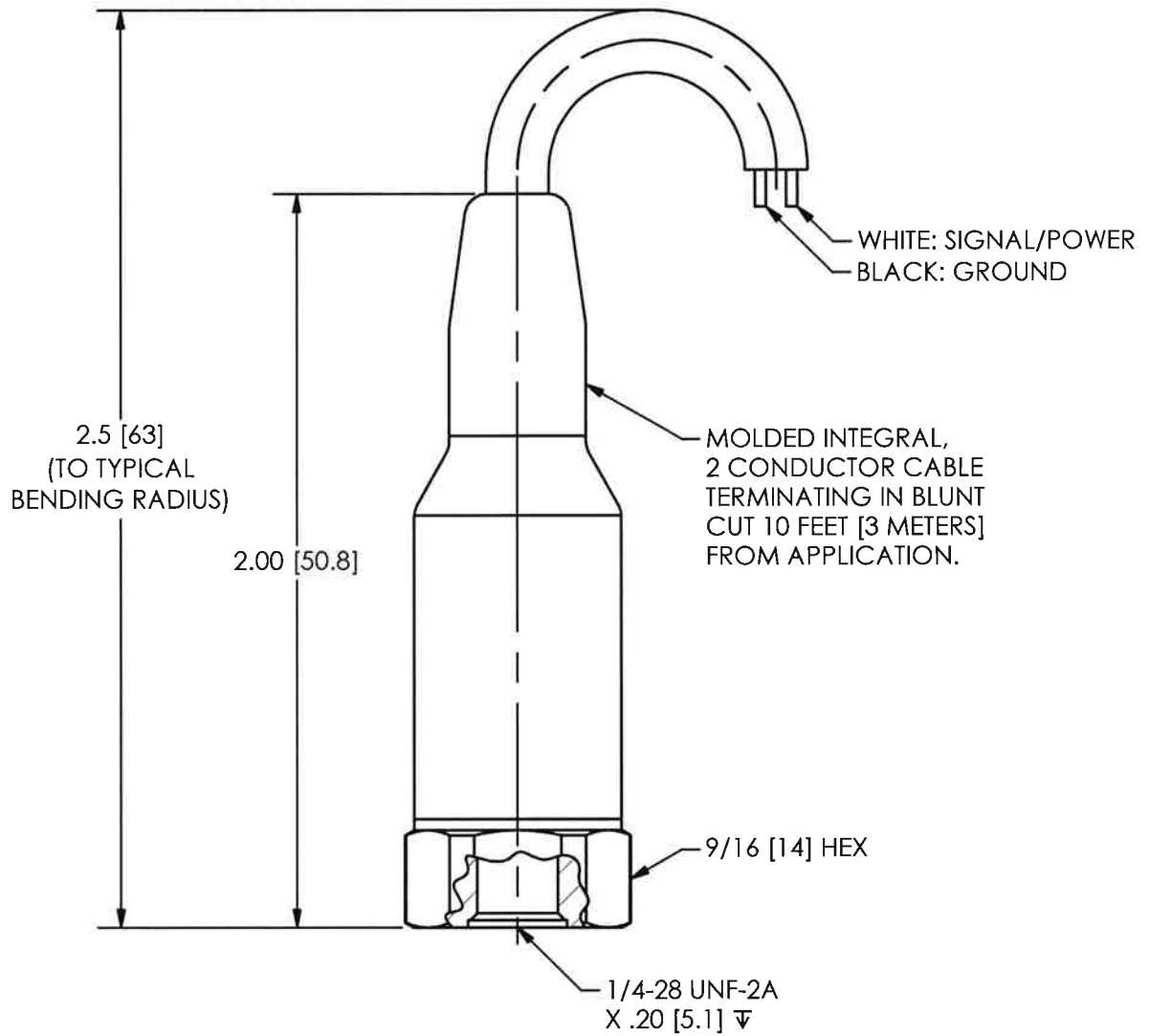

UNLESS OTHERWISE SPECIFIED TOLERANCES ARE:

DIMENSIONS IN INCHES

DECIMALS XX ±.03
XXX ±.010

ANGLES ± 2 DEGREES

DIMENSIONS IN MILLIMETERS
[IN BRACKETS]

DECIMALS X ± 0.8
XX ± 0.25

ANGLES ± 2 DEGREES

FILLETS AND RADII
.003 - .005

FILLETS AND RADII
0.07 - 0.13

DRAWN

CHECKED

ENGINEER

MDF 8/13/09 ECB 8/14/09 MJN 8/13/09

TITLE

OUTLINE DRAWING
MODEL 608A1X, M
ACCELEROMETER

PCB PIEZOTRONICS INC.

3425 WALDEN AVE. DEPEW, NY 14043
(716) 684-0001 E-MAIL: sales@pcb.com

CODE IDENT. NO.
52681

DWG. NO.

12013

SCALE: 2 X

SHEET 1 OF 1



LCIE

1 ATTESTATION D'EXAMEN DE TYPE

- 2 **Appareil ou système de protection** destiné à être utilisé en atmosphères explosibles (**Directive 94/9/CE**)
- 3 Numéro de l'attestation d'examen de type
LCIE 06 ATEX 6032 X
- 4 Appareil ou système de protection :
Capteurs de vibrations
Type : EX602Dxx, EX603Cxx, EX606Bxx, EX607Axx,
EX608Axx
- 5 Demandeur : IMI Sensors A PCB Piezotronics Div.
Adresse : 3425 Walden Avenue
Depew, New York 14043 USA
- 7 Cet appareil ou système de protection et ses variantes éventuelles acceptées sont décrits dans l'annexe de la présente attestation et dans les documents descriptifs cités en référence.
- 8 Le LCIE certifie que cet appareil ou système de protection est conforme aux exigences essentielles de sécurité et de santé pour la conception et la construction d'appareils et de systèmes de protection destinés à être utilisés en atmosphères explosibles, données dans l'annexe II de la directive 94/9/CE du Parlement européen et du Conseil du 23 mars 1994.

Les résultats des vérifications et essais figurent dans le rapport confidentiel N° 60042410/542370.
- 9 Le respect des exigences essentielles de sécurité et de santé est assuré par la conformité à :
- EN 60075-15 (2005)
- 10 Le signe X lorsqu'il est placé à la suite du numéro de l'attestation, indique que cet appareil ou système de protection est soumis aux conditions spéciales pour une utilisation sûre, mentionnées dans l'annexe de la présente attestation.
- 11 Cette attestation d'examen de type concerne uniquement la conception et la construction de l'appareil ou du système de protection spécifié, conformément à l'annexe III de la directive 94/9/CE.
Des exigences supplémentaires de la directive sont applicables pour la fabrication et la fourniture de l'appareil ou du système de protection. Ces dernières ne sont pas couvertes par la présente attestation.
- 12 Le marquage de l'appareil ou du système de protection doit comporter les informations détaillées au point 15.

1 TYPE EXAMINATION CERTIFICATE

- 2 **Equipment or protective system** intended for use in potentially explosive atmospheres (**Directive 94/9/EC**)
- 3 Type Examination Certificate number
LCIE 06 ATEX 6032 X
- 4 Equipment or protective system :
Vibration sensors
Type : EX602Dxx, EX603Cxx, EX606Bxx, EX607Axx,
EX608Axx
- 5 applicant : IMI Sensors A PCB Piezotronics Div.
Address : 3425 Walden Avenue
Depew, New York 14043 USA
- 7 This equipment or protective system and any acceptable variation thereto is specified in the schedule to this certificate and the documents therein referred to.
- 8 LCIE certifies that this equipment or protective system has been found to comply with the essential Health and Safety Requirements relating to the design and construction of equipment and protective system intended for use in potentially explosive atmospheres, given in Annex II of the Directive 94/9/EC of the European Parliament and Council of 23 March 1994.

The examination and test results are recorded in confidential report N° 60042410/542370.
- 9 Compliance with the Essential Health and Safety Requirements has been assured by compliance with :
- EN 60079-15 (2005)
- 10 If the sign X is placed after the certificate number, it indicates that the equipment or protective system is subject to special conditions for safe use specified in the schedule to this certificate.
- 11 This type examination certificate relates only to the design and construction of this specified equipment or protective system in accordance with annex III to the directive 94/9/EC.

Further requirements of the Directive apply to the manufacture and supply of this equipment or protective system. These are not covered by this certificate.
- 12 The marking of the equipment or protective system shall include informations as detailed at 15.

Fontenay-aux-Roses, le 22 mai 2006

Le responsable de certification ATEX
ATEX certification manager



Henri CERVELLO

Seul le texte en français peut engager la responsabilité du LCIE. Ce document ne peut être reproduit que dans son intégralité, sans aucune modification
The LCIE's liability applies only on the French text. This document may be reproduced in its entirety and without any change

13 ANNEXE

14 ATTESTATION D'EXAMEN DE TYPE

LCIE 06 ATEX 6032 X

15 DESCRIPTION DE L'APPAREIL OU DU SYSTEME DE PROTECTION

Capteurs de vibrations

Type : EX602Dxx, EX603Cxx, EX606Bxx, EX607Axx, EX608Axx

Ce capteur est composé d'un ensemble piezo-cristal, d'une carte électronique et d'un connecteur ou un câble intégré.

Modèles concernés :

EX602D01,EX603C01,EX606B01,EX607A01
EX602D11,EX603C11,EX606B11,EX607A11,EX608A11
EX602D61,EX603C61,EX606B61,EX607A61

Paramètres spécifiques du ou des modes de protection concernés :

Modèle / Model	U (V)	I (mA)	P (W)
EX602D01,EX603C01,EX606B01,EX607A01	28	200	1
EX602D11,EX603C11,EX606B11,EX607A11,EX608A11	28	200	1
EX602D61,EX603C61,EX606B61,EX607A61	28	200	1

Le marquage doit être :

IMI Adresse :

Type : EX 60... (1)

N° de fabrication :Année de fabrication :

 II 3G EEx nL IIC T4

LCIE 06 ATEX 6032X

T amb. : - 40°C à + 121°C

(1) complété suivant le modèle

L'appareil doit également comporter le marquage normalement prévu par les normes de construction qui le concerne.

16 DOCUMENTS DESCRIPTIFS

Dossier de certification N° 33701 du 28/03/2006.

Ce document comprend 10 rubriques (25 pages).

17 CONDITIONS SPECIALES POUR UNE UTILISATION SÛRE

Ce matériel ne peut être placé qu'en atmosphère explosive zone 2.

Le matériel ne doit être raccordé qu'à un équipement dont les paramètres électriques sont compatibles aux valeurs mentionnées au paragraphe 15.

Température ambiante d'utilisation : - 40°C à + 121°C.

18 EXIGENCES ESSENTIELLES DE SECURITE ET DE SANTE

Couvertes par les normes listées au point 9.

19 VERIFICATIONS ET ESSAIS INDIVIDUELS

Néant.

13 SCHEDULE

14 TYPE EXAMINATION CERTIFICATE

LCIE 06 ATEX 6032 X

15 DESCRIPTION OF EQUIPMENT OR PROTECTIVE SYSTEM

Vibration sensors

Type : EX602Dxx, EX603Cxx, EX606Bxx, EX607Axx, EX608Axx

This apparatus is made of a piezo-crystal assembly, an electronic board and a connector or an integrated cable.

Models concerned :

EX602D01,EX603C01,EX606B01,EX607A01
EX602D11,EX603C11,EX606B11,EX607A11,EX608A11
EX602D61,EX603C61,EX606B61,EX607A61

Specific parameters of the modes(s) of protection concerned :

The marking shall be :

IMI Address :

Type : EX 60... (1)

Serial number :Year of construction :

 II 3G EEx nL IIC T4

LCIE 06 ATEX 6032X

T amb. : - 40°C to + 121°C

(1) completed following the model

The equipment shall also bear the usual marking required by the manufacturing standards applying to such equipment.

16 DESCRIPTIVE DOCUMENTS

Certification file N° 33701 dated 28/03/2006.

This file includes 10 items (25 pages).

17 SPECIAL CONDITIONS FOR SAFE USE

This equipment can be only mounted in explosive atmosphere zone 2.

The apparatus must be only connected to an equipment whose electrical parameters are compatible with the values mentioned clause 15.

Operating ambient temperature : - 40°C to + 121°C.

18 ESSENTIAL HEALTH AND SAFETY REQUIREMENTS

Covered by standards listed at 9.

19 ROUTINE VERIFICATIONS AND TESTS

None.



LCIE

1 AVENANT D'ATTESTATION D'EXAMEN DE TYPE VOLONTAIRE

2 Appareil destiné à être utilisé en atmosphères explosibles (Directive 94/9/CE)

3 Numéro de l'avenant : LCIE 06 ATEX 6032 X / 01

4 Appareil

Capteurs de vibrations

Type : EX602Dxx, EX603Cxx, EX606Bxx, EX607Axx, EX608Axx

5 demandeur : IMI Sensors PCB Piezotronics Div.

15 DESCRIPTION DE L'AVENANT

Mise à jour normative selon les normes EN 60079-0 (2006) et EN 60079-15 (2005).

Les résultats des vérifications et essais figurent dans le rapport confidentiel N° 95367-590025-01.

Paramètres spécifiques du ou des modes de protection concerné(s) :

Inchangés.

Le marquage doit être :

IMI Sensors

Adresse :

Type : EX 60... (1)

N° de fabrication :Année de fabrication :

Ex II 3G Ex nL IIC T4

LCIE 06 ATEX 6032X

T amb. : - 40°C à + 121°C

(1) complété suivant le modèle

16 DOCUMENTS DESCRIPTIFS

Dossier de certification n° 33700 rév. A du 19/04/2010. Ce document comprend 10 rubriques (22 pages).

17 CONDITIONS SPECIALES POUR UNE UTILISATION SÛRE

Inchangées.

18 EXIGENCES ESSENTIELLES DE SECURITE ET DE SANTE

Couvertes par les normes listées au point 15.

19 VERIFICATIONS ET ESSAIS INDIVIDUELS

Chaque équipement devra avoir subi avec succès une épreuve de rigidité diélectrique conformément au paragraphe 34.2.1 de la norme EN 60079-15 (2005).

Fontenay-aux-Roses, le le 04 mai 2010.

1 VOLUNTARY SUPPLEMENTARY TYPE EXAMINATION CERTIFICATE

2 Equipment intended for use in potentially explosive atmospheres (Directive 94/9/EC)

3 Supplementary certificate number : LCIE 06 ATEX 6032 X / 01

4 Equipment

Vibration sensors

Type : EX602Dxx, EX603Cxx, EX606Bxx, EX607Axx, EX608Axx

5 Applicant : IMI Sensors PCB Piezotronics Div.

15 DESCRIPTION OF THE SUPPLEMENTARY CERTIFICATE

Normative update according to the standards EN 60079-0 (2006) and EN 60079-15 (2005).

The examination and test results are recorded in confidential report N° 95367-590025-01.

Specific parameters of the mode(s) of protection concerned:

Unchanged.

The marking shall be : xxxxxxxx

IMI Sensors

Address :

Type : EX 60... (1)

Serial number :Year of construction :

Ex II 3G Ex nL IIC T4

LCIE 06 ATEX 6032X

T amb. : - 40°C to + 121°C

(1) completed following the model

16 DESCRIPTIVE DOCUMENTS

Certification file n° 33700 Rev. A dated 2010/04/19. This file includes 10 items (22 pages).

17 SPECIAL CONDITIONS FOR SAFE USE

Unchanged.

18 ESSENTIAL HEALTH AND SAFETY REQUIREMENTS

Covered by standards listed at 15.

19 ROUTINE VERIFICATIONS AND TESTS

Each equipment shall be submitted to an electric strength test according to paragraph 34.2.1 from EN 60079-15 (2005).

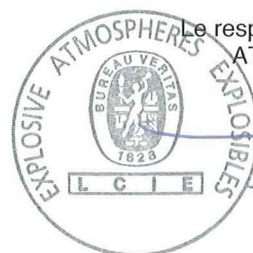

Le responsable de certification ATEX ATEX certification manager

Marc GILLAUX



LCIE

1 AVENANT D'ATTESTATION D'EXAMEN DE TYPE VOLONTAIRE

2 Appareil ou système de protection destiné à être utilisé en atmosphères explosibles (Directive 94/9/CE)

3 Numéro de l'avenant : LCIE 06 ATEX 6032 X / 02

4 Appareil ou système de protection : Capteur de vibration
Type : EX602Dxx, EX603Cxx, EX606Bxx, EX607Axx, EX608Axx

5 Demandeur : IMI Sensors
A PCB Piezoelectric Div.

15 DESCRIPTION DE L'AVENANT

Mise à jour normative suivant les normes EN 60079-0:2012 et EN 60079-15:2010.
Mise à jour des documents.

Les résultats des vérifications et essais figurent dans le rapport confidentiel N°120351-640382.

Paramètres spécifiques du ou des modes de protection concerné(s) : Inchangés.

Le marquage doit être : Modifié comme suit :
IMI Sensors Adresse : ...
Type : EX602Dxx, EX603Cxx, EX606Bxx, EX607Axx, EX608Axx (1)
Numéro de fabrication : ... Année de fabrication : ...

II 3 G
Ex nA IIC T4 Gc
LCIE 06 ATEX 6032 X
-40°C ≤ Ta ≤ +121°C
(1) complété avec le modèle

16 DOCUMENTS DESCRIPTIFS

Dossier technique n°33701 rev.B du 18/04/2013.
Ce dossier comprend 10 rubriques (25 pages).

17 CONDITIONS SPECIALES POUR UNE UTILISATION SURE

Inchangées.

18 EXIGENCES ESSENTIELLES DE SECURITE ET DE SANTE

Couvertes par les normes EN 60079-0:2009 et EN 60079-15:2010.

19 VERIFICATIONS ET ESSAIS INDIVIDUELS

Inchangés.

Fontenay-aux-Roses, le 20 AOUT 2013

1 SUPPLEMENTARY VOLUNTARY TYPE EXAMINATION CERTIFICATE

2 Equipment or protective system intended for use in potentially explosive atmospheres (Directive 94/9/EC)

3 Supplementary certificate number : LCIE 06 ATEX 6032 X / 02

4 Equipment or protective system : Vibration sensor
Type : EX602Dxx, EX603Cxx, EX606Bxx, EX607Axx, EX608Axx

5 Applicant : IMI Sensors
A PCB Piezoelectric Div.

15 DESCRIPTION OF THE SUPPLEMENTARY CERTIFICATE

Normative update according standards EN 60079-0:2012 and EN 60079-15:2010.
Update of documents.

The examination and test results are recorded in confidential report N°120351-640382.

Specific parameters of the concerned protection mode : Unchanged.

The marking shall be : Modified as follow :
IMI Sensors Address : ...
Type : EX602Dxx, EX603Cxx, EX606Bxx, EX607Axx, EX608Axx (1)
Serial number : ... Year of construction : ...

II 3 G
Ex nA IIC T4 Gc
LCIE 06 ATEX 6032 X
-40°C ≤ Ta ≤ +121°C
(1) completed with the model

16 DESCRIPTIVE DOCUMENTS

Technical file n°33701 rev.B dated 2013/04/18.
This file includes 10 items (25 pages).

17 SPECIAL CONDITIONS FOR SAFE USE

Unchanged.

18 ESSENTIAL HEALTH AND SAFETY REQUIREMENTS

Covered by standards EN 60079-0:2009 and EN 60079-15:2010.

19 ROUTINE VERIFICATIONS AND TESTS

Unchanged.

Le responsable de certification ATEX
ATEX Certification Officer



Seul le texte en français peut engager la responsabilité du LCIE. Ce document ne peut être reproduit ou réimprimé en son intégralité, sans aucune modification.
The LCIE's liability applies only on the French text. This document may only be reproduced in its entirety and without any change.



LCIE

1 ATTESTATION D'EXAMEN CE DE TYPE

2 Appareil ou système de protection destiné à être utilisé en atmosphères explosibles (Directive 94/9/CE)

**3 Numéro de l'attestation d'examen CE de type
LCIE 06 ATEX 6033 X**

4 Appareil ou système de protection :

Capteurs de vibrations

Type : EX602Dxx, EX603Cxx, EX606Bxx, EX607Axx,
EX608Axx

**5 Demandeur : IMI Sensors A PCB Piezotronics Div.
Adresse : 3425 Walden Avenue
Depew, New York 14043 USA**

**6 Fabricant : IMI Sensors A PCB Piezotronics Div.
Adresse : 3425 Walden Avenue
Depew, New York 14043 USA**

7 Cet appareil ou système de protection et ses variantes éventuelles acceptées sont décrits dans l'annexe de la présente attestation et dans les documents descriptifs cités en référence.

8 Le LCIE, organisme notifié sous la référence 0081 conformément à l'article 9 de la directive 94/9/CE du Parlement européen et du Conseil du 23 mars 1994, certifie que cet appareil ou système de protection est conforme aux exigences essentielles de sécurité et de santé pour la conception et la construction d'appareils et de systèmes de protection destinés à être utilisés en atmosphères explosibles, données dans l'annexe II de la directive. Les résultats des vérifications et essais figurent dans le rapport confidentiel N° 60042416/542372.

9 Le respect des exigences essentielles de sécurité et de santé est assuré par la conformité à :
- EN 50014 (1997) + amendements 1 et 2
- EN 50020 (2002)

10 Le signe X lorsqu'il est placé à la suite du numéro de l'attestation, indique que cet appareil ou système de protection est soumis aux conditions spéciales pour une utilisation sûre, mentionnées dans l'annexe de la présente attestation.

11 Cette attestation d'examen CE de type concerne uniquement la conception et la construction de l'appareil ou du système de protection spécifié, conformément à l'annexe III de la directive 94/9/CE.

Des exigences supplémentaires de la directive sont applicables pour la fabrication et la fourniture de l'appareil ou du système de protection. Ces dernières ne sont pas couvertes par la présente attestation.

12 Le marquage de l'appareil ou du système de protection doit comporter les informations détaillées au point 15.

Fontenay-aux-Roses, le 22 mai 2006

1 EC TYPE EXAMINATION CERTIFICATE

2 Equipment or protective system intended for use in potentially explosive atmospheres (Directive 94/9/EC)

**3 EC type examination certificate number
LCIE 06 ATEX 6033 X**

4 Equipment or protective system :

Vibration sensors

Type : EX602Dxx, EX603Cxx, EX606Bxx, EX607Axx,
EX608Axx

**5 Applicant : IMI Sensors A PCB Piezotronics Div.
Address : 3425 Walden Avenue
Depew, New York 14043 USA**

**6 Manufacturer : IMI Sensors A PCB Piezotronics Div.
Address : 3425 Walden Avenue
Depew, New York 14043 USA**

7 This equipment or protective system and any acceptable variation thereto is specified in the schedule to this certificate and the documents therein referred to.

8 LCIE, notified body number 0081 in accordance with article 9 of the Directive 94/9/EC of the European Parliament and the Council of 23 March 1994, certifies that this equipment or protective system has been found to comply with the essential Health and Safety Requirements relating to the design and construction of equipment and protective systems intended for use in potentially explosive atmospheres, given in Annex II to the Directive. The examination and test results are recorded in confidential report N° 60042416/542372.

9 Compliance with the Essential Health and Safety Requirements has been assured by compliance with :
- EN 50014 (1997) + amendments 1 and
- EN 50020 (2002)

10 If the sign X is placed after the certificate number, it indicates that the equipment or protective system is subject to special conditions for safe use specified in the schedule to this certificate.

11 This EC type examination certificate relates only to the design and construction of this specified equipment or protective system in accordance with annex III to the directive 94/9/EC.

Further requirements of the directive apply to the manufacturing process and supply of this equipment or protective system. These are not covered by this certificate.

12 The marking of the equipment or protective system shall include informations as detailed at 15.

responsable de certification ATEX
ATEX certification manager



Henri CERVELLO
Henri CERVELLO

Seul le texte en français peut engager la responsabilité du LCIE. Ce document ne peut être reproduit que dans son intégralité, sans aucune modification
The LCIE's liability applies only on the French text. This document may only be reproduced in its entirety and without any change



LCIE

13 ANNEXE

13 SCHEDULE

14 ATTESTATION D'EXAMEN CE DE TYPE

14 EC TYPE EXAMINATION CERTIFICATE

LCIE 06 ATEX 6033 X

LCIE 06 ATEX 6033 X

15 DESCRIPTION DE L'APPAREIL OU DU SYSTEME DE PROTECTION

15 DESCRIPTION OF EQUIPMENT OR PROTECTIVE SYSTEM

Capteurs de vibrations

Vibration sensors

Type : EX602Dxx, EX603Cxx, EX606Bxx, EX607Axx, EX608Axx

Type : EX602Dxx, EX603Cxx, EX606Bxx, EX607Axx, EX608Axx

Ce capteur est composé d'un ensemble piezo-cristal, d'une carte électronique et d'un connecteur ou un câble intégré.

This apparatus is made of a piezo-crystal assembly, an electronic board and a connector or an integrated cable.

Modèles concernés :

Models concerned :

EX602D01, EX603C01, EX606B01, EX607A01
EX602D11, EX603C11, EX606B11, EX607A11, EX608A11
EX602D61, EX603C61, EX606B61, EX607A61

EX602D01, EX603C01, EX606B01, EX607A01
EX602D11, EX603C11, EX606B11, EX607A11, EX608A11
EX602D61, EX603C61, EX606B61, EX607A61

Paramètres spécifiques du ou des modes de protection concernés :

Specific parameters of the modes(s) of protection concerned:

Modèle / Model	Ui (V)	Ii (mA)	Pi (W)	Ci (nF)	Li (µH)
EX602D01, EX603C01, EX606B01, EX607A01	28	200	1	16,2	0
EX602D11, EX603C11, EX606B11, EX607A11, EX608A11	28	200	1	77,2	305
EX602D61, EX603C61, EX606B61, EX607A61	28	200	1	16,2	305

Le marquage doit être :

The marking shall be :

IMI Adresse :

IMI Address :

Type : EX 60... (1)

Type : EX 60... (1)

N° de fabrication : Année de fabrication :

Serial number : Year of construction :

Ex II 1G EEx ia IIC T4

Ex II 1G EEx ia IIC T4

LCIE 06 ATEX 6033X

LCIE 06 ATEX 6033X

T amb. : - 40°C à + 121°C

T amb. : - 40°C to + 121°C

(1) complété suivant le modèle

(1) completed following the model

L'appareil doit également comporter le marquage normalement prévu par les normes de construction qui le concerne.

The equipment shall also bear the usual marking required by the manufacturing standards applying to such equipment.

16 DOCUMENTS DESCRIPTIFS

16 DESCRIPTIVE DOCUMENTS

Dossier de certification N° 33699 du 28/03/2006.
Ce document comprend 10 rubriques (25 pages).

Certification file N° 33699 dated 28/03/2006.
This file includes 10 items (25 pages).

17 CONDITIONS SPECIALES POUR UNE UTILISATION SÛRE

17 SPECIAL CONDITIONS FOR SAFE USE

Ce matériel est un appareil de sécurité intrinsèque, il peut être placé en atmosphère explosible.

This equipment is an intrinsically safe apparatus, it can be mounted in explosive atmosphere.

Le matériel ne doit être raccordé qu'à un matériel associé de sécurité intrinsèque certifié et cette association doit être compatible du point de vue sécurité intrinsèque (voir paramètres électriques au paragraphe 15).

The apparatus must be only connected to a certified associated intrinsically safe equipment and this combination must be compatible regarding intrinsic safety rules (see electrical parameters clause 15).

Température ambiante d'utilisation : - 40°C à + 121°C.

Operating ambient temperature : - 40°C to + 121°C.

18 EXIGENCES ESSENTIELLES DE SECURITE ET DE SANTE

18 ESSENTIAL HEALTH AND SAFETY REQUIREMENTS

Couvertes par les normes listées au point 9.

Covered by standards listed at 9.

19 VERIFICATIONS ET ESSAIS INDIVIDUELS

19 ROUTINE VERIFICATIONS AND TESTS

Néant.

None.



LCIE

1 AVENANT D'ATTESTATION D'EXAMEN CE DE TYPE

2 Appareil ou système de protection destiné à être utilisé en atmosphères explosibles (Directive 94/9/CE)

3 Numéro de l'avenant : LCIE 06 ATEX 6033 X / 01

4 Appareil ou système de protection : Capteurs de vibrations
Type : EX602Dxx, EX603Cxx, EX606Bxx, EX607Axx, EX608Axx

5 Demandeur : IMI Sensors PCB Piezotronics Div.

15 DESCRIPTION DE L'AVENANT

Mise à jour normative selon les normes EN 60079-0 (2006) et EN 60079-11 (2007).

Les résultats des vérifications et essais figurent dans le rapport confidentiel N°95367-590025-02.

Paramètres spécifiques du ou des modes de protection concerné(s) : Inchangés.

Le marquage doit être : IMI Sensors
Adresse :
Type : EX 60... (1)
N° de fabrication :Année de fabrication :
Ex II 1 G Ex ia IIC T4
LCIE 06 ATEX 6033X
T amb. : - 40°C à + 121°C
(1) complété suivant le modèle

16 DOCUMENTS DESCRIPTIFS

Dossier de certification N° 33698 rév. A du 19/04/2010. Ce dossier comprend 10 rubriques (22 pages).

17 CONDITIONS SPECIALES POUR UNE UTILISATION SURE

Inchangées.

18 EXIGENCES ESSENTIELLES DE SECURITE ET DE SANTE

Couvertes par les normes listées au point 15.

19 VERIFICATIONS ET ESSAIS INDIVIDUELS
Néant.

1 SUPPLEMENTARY EC TYPE EXAMINATION CERTIFICATE

2 Equipment or protective system intended for use in potentially explosive atmospheres (Directive 94/9/EC)

3 Supplementary certificate number : LCIE 06 ATEX 6033 X / 01

4 Equipment or protective system : Vibration sensors
Type : EX602Dxx, EX603Cxx, EX606Bxx, EX607Axx, EX608Axx

5 Applicant : IMI Sensors PCB Piezotronics Div.

15 DESCRIPTION OF THE SUPPLEMENTARY CERTIFICATE

Normative update according to the standards EN 60079-0 (2006) and EN 60079-11 (2007).

The examination and test results are recorded in confidential report N° 95367-590025-02.

Specific parameters of the mode(s) of protection concerned: Unchanged.

The marking shall be : IMI Sensors
Address :
Type : EX 60... (1)
Serial number :Year of construction :
Ex II 1 G Ex ia IIC T4
LCIE 06 ATEX 6033X
T amb. : - 40°C to + 121°C
(1) completed following the model

16 DESCRIPTIVE DOCUMENTS

Certification file N° 33698 Rev. A dated 2010/04/19. This file includes 10 items (22 pages).

17 SPECIAL CONDITIONS FOR SAFE USE

Unchanged.

18 ESSENTIAL HEALTH AND SAFETY REQUIREMENTS

Covered by standards listed at 15.

19 ROUTINE VERIFICATIONS AND TESTS
None.

Fontenay-aux-Roses, le 04 mai 2010.

Le responsable de certification ATEX
ATEX certification manager

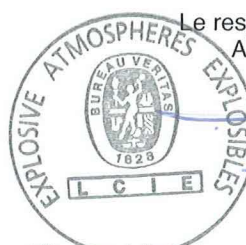

Marc GILLAUX



LCIE

1 AVENANT D'ATTESTATION D'EXAMEN CE DE TYPE

2 Appareil ou système de protection destiné à être utilisé en atmosphères explosibles (Directive 94/9/CE)

3 Numéro de l'avenant :

LCIE 06 ATEX 6033 X / 02

4 Appareil ou système de protection :

Capteurs de vibration

Type : EX602Dxx, EX603Cxx, EX606Bxx,
EX607Axx, EX608Axx

5 Demandeur : IMI Sensors
A PCB Piezoelectric Div.

15 DESCRIPTION DE L'AVENANT

Mise à jour normative suivant les normes EN 60079-0:2012 et EN 60079-11:2012.

Mise à jour des documents.

Les résultats des vérifications et essais figurent dans le rapport confidentiel N°120351-640382.

Paramètres spécifiques du ou des modes de protection concerné(s) :
Inchangés.

Le marquage doit être : Modifié comme suit :

IMI Sensors Adresse : ...
Type : EX602Dxx, EX603Cxx, EX606Bxx, EX607Axx,
EX608Axx (1)

Numéro de fabrication : ... Année de fabrication : ...

⊕ II 1 G

Ex ia IIC T4 Ga
LCIE 06 ATEX 6033 X
-40°C ≤ Ta ≤ +121°C

Ui ≤ ... V, Ii ≤ ... mA, Pi ≤ ...W, Ci ≤ ...nF, Li ≤ ...µH (1)
(1) complété en fonction du modèle

16 DOCUMENTS DESCRIPTIFS

Dossier technique N°33699 rev.B du 18/04/2013.
Ce dossier comprend 10 rubriques (25 pages).

17 CONDITIONS SPECIALES POUR UNE UTILISATION SURE

Inchangées.

18 EXIGENCES ESSENTIELLES DE SECURITE ET DE SANTE

Couvertes par les normes EN 60079-0:2012 et EN 60079-11:2012.

19 VERIFICATIONS ET ESSAIS INDIVIDUELS

Inchangés.

Fontenay-aux-Roses, le **20 AOUT 2013**

1 SUPPLEMENTARY EC TYPE EXAMINATION CERTIFICATE

2 Equipment or protective system intended for use in potentially explosive atmospheres (Directive 94/9/EC)

3 Supplementary certificate number :

LCIE 06 ATEX 6033 X / 02

4 Equipment or protective system :

Vibration sensors

Type : EX602Dxx, EX603Cxx, EX606Bxx, EX607Axx,
EX608Axx

5 Applicant : IMI Sensors
A PCB Piezoelectric Div.

15 DESCRIPTION OF THE SUPPLEMENTARY CERTIFICATE

Normative update according to EN60079-0:2012 and EN 60079-11:2012 standards.

Update of documents.

The examination and test results are recorded in confidential report N°120351-640382.

Specific parameters of the concerned protection mode :
Unchanged.

The marking shall be : Modified as follows :

IMI Sensors Address : ...
Type : EX602Dxx, EX603Cxx, EX606Bxx, EX607Axx,
EX608Axx (1)

Serial number : ... Year of construction : ...

⊕ II 1 G

Ex ia IIC T4 Ga
LCIE 06 ATEX 6033 X
-40°C ≤ Ta ≤ +121°C

Ui ≤ ... V, Ii ≤ ... mA, Pi ≤ ...W, Ci ≤ ...nF, Li ≤ ...µH (1)
(1) completed according to the model

16 DESCRIPTIVE DOCUMENTS

Technical file N°33699 rev.B dated 2013/04/18.
This file includes 10 items (25 pages).

17 SPECIAL CONDITIONS FOR SAFE USE

Unchanged.

18 ESSENTIAL HEALTH AND SAFETY REQUIREMENTS

Covered by the standards EN 60079-0:2012 and EN 60079-11:2012.

19 ROUTINE VERIFICATIONS AND TESTS

Unchanged.

Le responsable de certification ATEX
ATEX Certification Officer

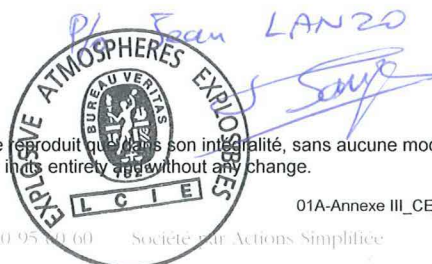

Seul le texte en français peut engager la responsabilité du LCIE. Ce document ne peut être reproduit qu'à son intégralité, sans aucune modification.
The LCIE's liability applies only on the French text. This document may only be reproduced in its entirety and without any change.

EC Declaration of Conformity PS 060
In Accordance with ISO/IEC 17050

Manufacturer: PCB Piezotronics, Inc. 3425 Walden Avenue Depew, New York 14043 USA	Authorized European Representative: PCB Piezotronics Europe GmbH Porschestraße 20-30 41836 Hückelhoven, Germany
--	--

Certifies that type of equipment: ICP® Industrial Sensor(s)

Whose Product Models Include: EX602Dxx, EX603Cxx, EX606Bxx, EX607Axx, EX608Axx Series
 Note: "xx," is a place holder for two numbers.
 For example: EX602D01Industrial Vibration Sensor

These letters and numbers are included in the model numbers of the series. For details see the related data sheets.

This declaration is applicable to all Sensor(s) of the above series which have the CE & (EX) ATEX mark on their data sheets and where those data sheets refer to this declaration of conformity. The data sheets for all model numbers referenced above, which include the CE & (EX) ATEX mark on such data sheets and refer to this Declaration of Conformity are hereby incorporated by reference into this Declaration.

Conform to the following EC Directive(s) when installed per product documentation:	2004/108/EC 94/9/EC	EMC directive ATEX
---	------------------------	-----------------------

Standards to which Conformity is Declared:

Harmonized Standards	EN61326-1:2006 EN61326-2-3: 2006 EN61010-1:2001 EN60079-0(2012) EN60079-11(2012)	Electrical Equipment for Measurement, Control and Laboratory Use- EMC Electrical Equipment for Measurement, Control and Laboratory Use- EMC Safety Standard General Explosive Atmosphere Intrinsic safe, I
Emissions Test Standards	EN 55011 (2007)	Industrial, scientific and medical(ISM) radio frequency equipment Electromagnetic disturbance characteristics- Limits and methods of Measurement Class B
Immunity Test Standards	EN 61000-4-2:2001 EN 61000-4-3:2006 EN 61000-4-4:2004 EN 61000-4-5:2005 EN 61000-4-6:2006 EN 61000-4-8:2001	Electrostatic discharge (ESD) Radiated, radio-frequency, electromagnetic field immunity Electrical fast transient (EFT) / Burst immunity Surge immunity Immunity to RF conducted line disturbances Power frequency magnetic field immunity
Test Reports	EMC Reports Safety Reports	GM29028c, GM29030c, GM29032c, GM29045c GM29029s, GM29031s, GM29033s, GM29046s
	ATEX Cert IECEX Cert	LCIE 06 ATEX 6033X Ex ia IIC T4 Ga IECEX LCIE 13.0045X Ex ia IIC T4 Ga
Notified Body Name		Laboratoire Central des Industries Electriques (0081)
Notified Body's Address		FONTENAY-AUX-ROSES (Head Office) 33, avenue du Général Leclerc FR- 92260 Fontenay-aux-Roses Tel. : + 33 1 40 95 60 60 Fax : + 33 1 40 95 86 56

I, the undersigned, hereby declare that the equipment specified above conforms to the above Directive(s) Standard(s)

Place: Depew, NY **Date:** 09/18/2013

Signature: 

 Name: Kenneth J. Gonyea Jr.

 Title: V.P. Manufacturing



Certificate of Compliance

Certificate: 1469131 (LR 103134)

Master Contract: 184981

Project: 1750643

Date Issued: 2006/04/18

Issued to: Industrial Monitoring Instr. (IMI)

A Div. of PCB Piezotronics, Inc.
3425 Walden Ave
Depew, NY 14043
USA
Attention: Ms. Joan Czuba

The products listed below are eligible to bear the CSA Mark shown with adjacent indicators 'C' and 'US'



Issued by: Ron Wildish

Authorized by: Patricia Pasemko, Operations Manager

PRODUCTS

- CLASS 2258 84** - PROCESS CONTROL EQUIPMENT - Intrinsically Safe, Entity - - For Hazardous Locations - Certified to US Standards
- CLASS 2258 04** - PROCESS CONTROL EQUIPMENT - Intrinsically Safe, Entity - For Hazardous Locations

Class I, Div. 1, Groups A, B, C and D; Class II, Div. 1, Groups E, F and G; Class III, Div 1:

Exia IIC T4:

AExia IIC T4:

The 'C' and 'US' indicators adjacent to the CSA Mark signify that the product has been evaluated to the applicable CSA and ANSI/UL Standards, for use in Canada and the U.S., respectively. This 'US' indicator includes products eligible to bear the 'NRTL' indicator. NRTL, i.e. National Recognized Testing Laboratory, is a designation granted by the U.S. Occupational Safety and Health Administration (OSHA) to laboratories which have been recognized to perform certification to U.S. Standards.



CSA INTERNATIONAL

Certificate: 1469131 (LR 103134)

Master Contract: 184981

Project: 1750643

Date Issued: 2006/04/18

- Model EX602D0x, EX603C0x, EX606B0x and EX607A0x Vibration Sensors, input rated 28V dc max, 20mA; intrinsically safe with entity parameters of: $U_i (V_{max}) = 30 \text{ V}$, $I_i (I_{max}) = 200 \text{ mA}$, $P_i = 1 \text{ W}$, $C_i = 16.2 \text{ nF}$, $L_i = 0$; when installed per installation dwg. 29876; Temp. Code T4 @ Max. Ambient 121 Deg. C.

- Model EX602D1x, EX603C1x, EX606B1x, EX607A1x and EX608A1x Vibration Sensors, input rated 28V dc max, 20mA; intrinsically safe with entity parameters of: $U_i (V_{max}) = 30 \text{ V}$, $I_i (I_{max}) = 200 \text{ mA}$, $P_i = 1 \text{ W}$, $C_i = 77.2 \text{ nF}$, $L_i = 305 \text{ uH}$; when installed per installation dwg. 29876; Temp. Code T4 @ Max. Ambient 121 Deg. C.

- Model EX602D6x, EX603C6x, EX606B6x and EX607A6x Vibration Sensors, input rated 28V dc max, 20mA; intrinsically safe with entity parameters of: $U_i (V_{max}) = 30 \text{ V}$, $I_i (I_{max}) = 200 \text{ mA}$, $P_i = 1 \text{ W}$, $C_i = 77.2 \text{ nF}$, $L_i = 305 \text{ uH}$; when installed per installation dwg. 29876; Temp. Code T4 @ Max. Ambient 121 Deg. C.

- Model 200350 Vibration Sensors, input rated 28 Vdc max, 20 mA max; intrinsically safe with entity parameters of: $U_i (V_{max}) = 30 \text{ V}$, $I_i (I_{max}) = 200 \text{ mA}$, $P_i = 1 \text{ W}$, $C_i = 16.2 \text{ nF}$, $L_i = 0$; when installed per installation Dwg. 22775; Temp. Code T4 @ Max Ambient 121 Deg C.

Note: The "x" in the model code may be any number from 0 to 9, which denotes variations in sensor sensitivity.

CLASS 2258 03 - PROCESS CONTROL EQUIPMENT - Intrinsically Safe and Non-Incendive Systems - For Hazardous Locations

CLASS 2258 83 - PROCESS CONTROL EQUIPMENT - Intrinsically Safe and Non-Incendive Systems - For Hazardous Locations - CERTIFIED TO U.S. STANDARDS

Class I, Div. 2, Groups A, B, C and D:

ExnL IIC T4:

AExnA IIC T4:

- Model EX602D0x, EX603C0x, EX606B0x and EX607A0x Vibration Sensors, input rated 28V dc max, 20mA; non-incendive with entity parameters of: $U_i (V_{max}) = 30 \text{ V}$, $I_i (I_{max}) = 200 \text{ mA}$, $P_i = 1 \text{ W}$, $C_i = 16.2 \text{ nF}$, $L_i = 0$; when installed per installation dwg. 29876; Temp. Code T4 @ Max. Ambient 121 Deg. C.

- Model EX602D1x, EX603C1x, EX606B1x, EX607A1x and EX608A1x Vibration Sensors, input rated 28V dc max, 20mA; non-incendive with entity parameters of: $U_i (V_{max}) = 30 \text{ V}$, $I_i (I_{max}) = 200 \text{ mA}$, $P_i = 1 \text{ W}$, $C_i = 77.2 \text{ nF}$, $L_i = 305 \text{ uH}$; when installed per installation dwg. 29876; Temp. Code T4 @ Max. Ambient 121 Deg. C.



Certificate: 1469131 (LR 103134)

Master Contract: 184981

Project: 1750643

Date Issued: 2006/04/18

- Model EX602D6x, EX603C6x, EX606B6x and EX607A6x Vibration Sensors, input rated 28V dc max, 20mA; non-incendive with entity parameters of: $U_i (V_{max}) = 30 \text{ V}$, $I_i (I_{max}) = 200 \text{ mA}$, $P_i = 1 \text{ W}$, $C_i = 77.2 \text{ nF}$, $L_i = 305 \text{ uH}$; when installed per installation dwg. 29876; Temp. Code T4 @ Max. Ambient 121 Deg. C.

Notes:

1. For Canadian Installations, sensor case must be bonded to ground according to Section 18-182 of the CEC, Part 1.
2. For US Installations, sensor case must be bonded to ground according to Article 501.16 of the NEC.
3. The "x" in the model code may be any number from 0 to 9, which denotes variations in sensor sensitivity.

Class I, Div. 2, Groups A, B, C and D:

ExnL IICT4:

- Model 200350 Vibration Sensor, input rated 28 Vdc max, 20 mA max; non-incendive when connected to CSA Certified Power/Signal Monitoring units when installed per installation Dwg. 22775; Temp. Code T4 @ Max Ambient 121 Deg C.

Note: Sensor case must be bonded to ground according to Section 18-182 of the CEC, Part 1 and according to Article 501.16 of the NEC as applicable.

APPLICABLE REQUIREMENTS

Class 2258 04 & 2258 84

CSA Std C22.2 No. 142-M1987 - Process Control Equipment

CAN/CSA-C22.2 No. 157-92 - Intrinsically Safe and Non-Incendive Equipment for Use in Hazardous Locations

UL Std No. 913 - Intrinsically Safe Apparatus and Associated Apparatus for Use in Class I, II and III, Division 1, Hazardous Locations

UL Std No. 916 - Energy Management Equipment

CAN/CSA-E60079-0:02 - Electrical Apparatus for Explosive Gas Atmospheres, Part 0: General Requirements

CAN/CSA- E60079-11:02 - Electrical apparatus for explosive gas atmospheres, Part 11: Intrinsic Safety "i"

ANSI/UL 60079-0:02 - Electrical Apparatus for Explosive Gas Atmospheres - Part 0: General Requirements

ANSI/UL 60079-11:02 - Electrical Apparatus for Explosive Gas Atmospheres - Part 11: Intrinsic Safety "i"



Certificate: 1469131 (LR 103134)-

Master Contract: 184981

Project: 1750643

Date Issued: 2006/04/18

Class 2258 03 & 2258 83

CSA Std C22.2 No. 142-M1987 - Process Control Equipment

CSA Std C22.2 No. 213-M1987 - Non-Incendive Electrical Equipment for Use in Class I, Division 2 Hazardous Locations

UL Std No. 916 - Energy Management Equipment

UL Std. No. 1604 - Electrical Equipment for Use in Class I and II, Division 2; Class III Hazardous (Classified) Locations

FM Std. No. 3600-1998 - Electrical Equipment for Use in Hazardous (Classified) Locations – General Requirements

FM Std. No. 3611-1999 - Nonincendive Electrical Equipment for Use in Class I and II, Division 2, and Class III, Divisions 1 and 2, Hazardous (Classified) Locations

CAN/CSA- E60079-15:02 - Electrical apparatus for explosive gas atmospheres, Part 15: Type of Protection “n”

ANSI/UL 60079-15:02 - Electrical Apparatus for Explosive Gas Atmospheres - Part 15: Type of Protection “n”.



CSA INTERNATIONAL

Supplement to Certificate of Compliance

Certificate: 1469131

Master Contract: 184981

The products listed, including the latest revision described below, are eligible to be marked in accordance with the referenced Certificate.

Product Certification History

Project	Date	Description
1750643	2006/04/18	Update to Include models EX602Dxx, EX606Bxx, EX607Axx and EX608A1x; addition of models EX603C1x and EX603C6x.
1469131	2003/08/22	Original Certification - Models 603C01 and 200350.