



**Model 640B61**

**4-20 mA Output Velocity Sensor**

**Installation and Operating Manual**

**For assistance with the operation of this product,  
contact PCB Piezotronics, Inc.**

**Toll-free: 800-959-4464**

**24-hour SensorLine: 716-684-0001**

**Fax: 716-684-3823**

**E-mail: [imi@pcb.com](mailto:imi@pcb.com)**

**Web: [www.imi-sensors.com](http://www.imi-sensors.com)**



**The information contained in this document supersedes all similar information that may be found elsewhere in this manual.**

**Total Customer Satisfaction** – PCB Piezotronics guarantees Total Customer Satisfaction. If, at any time, for any reason, you are not completely satisfied with any PCB product, PCB will repair, replace, or exchange it at no charge. You may also choose to have your purchase price refunded in lieu of the repair, replacement, or exchange of the product.

**Service** – Due to the sophisticated nature of the sensors and associated instrumentation provided by PCB Piezotronics, user servicing or repair is not recommended and, if attempted, may void the factory warranty. Routine maintenance, such as the cleaning of electrical connectors, housings, and mounting surfaces with solutions and techniques that will not harm the physical material of construction, is acceptable. Caution should be observed to insure that liquids are not permitted to migrate into devices that are not hermetically sealed. Such devices should only be wiped with a dampened cloth and never submerged or have liquids poured upon them.

**Repair** – In the event that equipment becomes damaged or ceases to operate, arrangements should be made to return the equipment to PCB Piezotronics for repair. User servicing or repair is not recommended and, if attempted, may void the factory warranty.

**Calibration** – Routine calibration of sensors and associated instrumentation is

recommended as this helps build confidence in measurement accuracy and acquired data. Equipment calibration cycles are typically established by the users own quality regimen. When in doubt about a calibration cycle, a good “rule of thumb” is to recalibrate on an annual basis. It is also good practice to recalibrate after exposure to any severe temperature extreme, shock, load, or other environmental influence, or prior to any critical test.

PCB Piezotronics maintains an ISO-9001 certified metrology laboratory and offers calibration services, which are accredited by A2LA to ISO/IEC 17025, with full traceability to N.I.S.T. In addition to the normally supplied calibration, special testing is also available, such as: sensitivity at elevated or cryogenic temperatures, phase response, extended high or low frequency response, extended range, leak testing, hydrostatic pressure testing, and others. For information on standard recalibration services or special testing, contact your local PCB Piezotronics distributor, sales representative, or factory customer service representative.

**Returning Equipment** – *Following these procedures will insure that your returned materials are handled in the most expedient manner.* Before returning any equipment to PCB Piezotronics, contact your local distributor, sales representative, or factory customer service representative to obtain a Return

Materials Authorization (RMA) Number. This RMA number should be clearly marked on the outside of all package(s) and on the packing list(s) accompanying the shipment. A detailed account of the nature of the problem(s) being experienced with the equipment should also be included inside the package(s) containing any returned materials.

A Purchase Order, included with the returned materials, will expedite the turn-around of serviced equipment. It is recommended to include authorization on the Purchase Order for PCB to proceed with any repairs, as long as they do not exceed 50% of the replacement cost of the returned item(s). PCB will provide a price quotation or replacement recommendation for any item whose repair costs would exceed 50% of replacement cost, or any item that is not economically feasible to repair. For routine calibration services, the Purchase Order should include authorization to proceed and return at current pricing, which can be obtained from a factory customer service representative.

**Warranty** – All equipment and repair services provided by PCB Piezotronics, Inc. are covered by a limited warranty against defective material and workmanship for a period of one year from date of original purchase. Contact

PCB for a complete statement of our warranty. Expendable items, such as batteries and mounting hardware, are not covered by warranty. Mechanical damage to equipment due to improper use is not covered by warranty. Electronic circuitry failure caused by the introduction of unregulated or improper excitation power or electrostatic discharge is not covered by warranty.

**Contact Information** – International customers should direct all inquiries to their local distributor or sales office. A complete list of distributors and offices can be found at [www.pcb.com](http://www.pcb.com). Customers within the United States may contact their local sales representative or a factory customer service representative. A complete list of sales representatives can be found at [www.pcb.com](http://www.pcb.com). Toll-free telephone numbers for a factory customer service representative, in the division responsible for this product, can be found on the title page at the front of this manual. Our ship to address and general contact numbers are:

PCB Piezotronics, Inc.  
3425 Walden Ave.  
Depew, NY 14043 USA  
Toll-free: (800) 828-8840  
24-hour SensorLine<sup>SM</sup>: (716) 684-0001  
Website: [www.pcb.com](http://www.pcb.com)  
E-mail: [info@pcb.com](mailto:info@pcb.com)

**Model 640/641/645/646 B Series Industrial 4-20mA Sensor**

CE



**Operating Guide with Enclosed Warranty Information**

**3425 Walden Avenue, Depew, New York 14043-2495**

**Phone (716) 684-0003**

**Fax (716) 684-3823**

**Toll Free Line 1-800-959-4IMI**

MANUAL NUMBER: 25317  
MANUAL REVISION: D  
ECN NUMBER: 26800

## **Table of Contents**

---

<i>Introduction</i> .....	<i>Page 3</i>
<i>General Features</i>	
<i>Dimension Drawing</i> .....	<i>Page 4</i>
<i>Operation and Wiring</i> .....	<i>Page 5</i>
<i>Standard Wiring</i>	
<i>Taking Measurements</i>	
<i>RV Option</i>	
<i>RVVO Option</i>	
<i>TO Option</i>	
<i>Installation</i> .....	<i>Page 9</i>
<i>Direct Adhesive Mount</i>	
<i>Standard Stud Mount</i>	
<i>Adhesive Stud Mount</i>	
<i>Magnetic Mount</i>	
<i>ESD Sensitivity</i> .....	<i>Page 13</i>

## **Warranty/Serviceing**

---

<i>Warranty, Service &amp; Return Procedure</i> .....	<i>Page 14</i>
<i>Customer Service</i> .....	<i>Page 15</i>

## Introduction

The Model 640/641/645/646 B Series Industrial 4-20mA Sensors combine the capabilities of a piezoelectric vibration sensor and a 4-20mA vibration transmitter. The sensor outputs a 4-20mA signal that is proportional to the overall velocity or acceleration of the machinery. Ideal for monitoring the vibration of process equipment such as fans, motors and pumps, the output of the sensor is used for process control or predictive maintenance. There are many options in this series. Please refer to specific specification sheets for further details.

### **General Features**

- Imbedded Piezoelectric Accelerometer for improved accuracy and frequency response.
- Vibration range can be in Acceleration or Velocity.
- Allows for continuous vibration monitoring of critical applications.
- Reduces sophisticated vibration analysis requirements.
- RV (Raw Vibration) option for conducting frequency analysis and machinery diagnostics.
- RVVO (Raw Vibration Velocity Output) option for conducting freq. analysis and machinery diagnosis.
- TO (Temperature Output) option via an independent 4-20mA loop.
- Readily interfaces to existing process control and predictive maintenance equipment.
- Rugged stainless steel construction for applications in harsh environments.
- Flexible design allows for various custom requirements.

**Dimension Drawing**

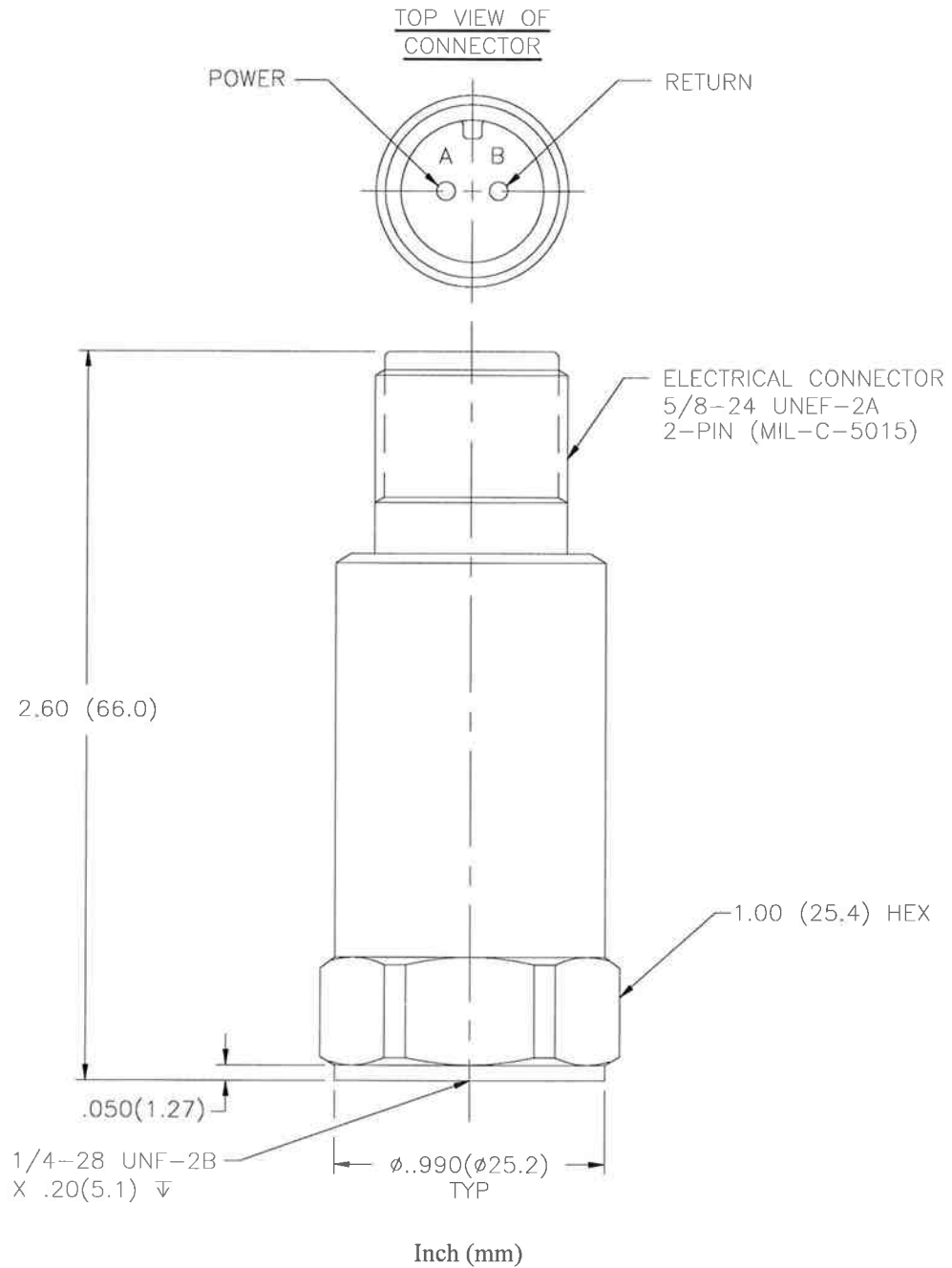

## Operation and Wiring

### Standard Wiring

The Model 640/641/645/646 B Series operates from a standard 2-wire, 4-20mA loop. If using a loop powered unit, attach the positive (+) input from the power supply to Pin A or **Red** wire on the sensor and the negative (-) input from the power supply to Pin B or **Blue** wire of the sensor.

**Figure 1 – wiring: loop powered**

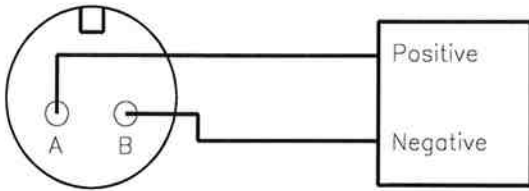

**Figure 2 – wiring: loop powered/DC source**

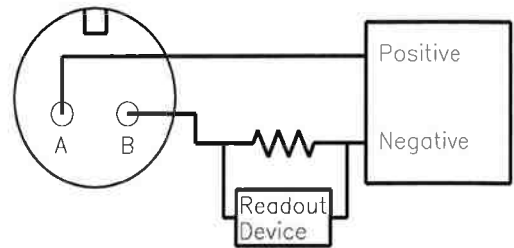

If using a standard DC power supply, install either an ammeter and/or load resistor in line with the output, Pin B or **Blue** wire.

The resistor will generate a DC voltage that is proportional to current by:

$$V = IR$$

*If  $R = 500$  ohms and  $I = 6$  mA, then  $V = 3$  VDC*

**Note:**

- Resistor value must be less than:  $(V_{\text{supply}} - 12) \times 50$ .
- For integral cable sensors: RED wire is positive, BLUE wire is negative.



## Taking Measurements

When measuring the current output from the unit, use the following formula to calculate the vibration level:

$$\text{Vibration Output} = (\text{Measured Output} - 4\text{mA}) \times (\text{Full Scale Vibration Output} / 16\text{mA})$$

<b>Measured mA</b>	<b>640BX0</b>	<b>640BX1</b>	<b>640BX2</b>
4.00	0.0 ips, pk	0.0 ips, pk	0.0 ips, pk
8.00	0.125 ips, pk	0.25 ips, pk	0.5 ips, pk
12.0	0.25 ips, pk	0.5 ips, pk	1.0 ips, pk
15.75	0.37 ips, pk	0.73 ips, pk	1.47 ips, pk
20	0.5 ips, pk	1.0 ips, pk	2.0 ips, pk

<b>Measured mA</b>	<b>641BX0</b>	<b>641BX1</b>	<b>641BX2</b>
4.00	0.0 ips, rms	0.0 ips, rms	0.0 ips, rms
8.00	0.125 ips, rms	0.25 ips, rms	0.5 ips, rms
12.0	0.25 ips, rms	0.5 ips, rms	1.0 ips, rms
15.75	0.37 ips, rms	0.73 ips, rms	1.47 ips, rms
20	0.5 ips, rms	1.0 ips, rms	2.0 ips, rms

<b>Measured mA</b>	<b>645</b>	<b>646</b>
4.00	0.0 g rms	0.0 g rms
8.00	1.25 g rms	2.50 g rms
12.0	2.50 g rms	5.00 g rms
15.75	3.67 g rms	7.34 g rms
20	5.00 g rms	10.0 g rms

### RV Option

The RV (raw vibration) option includes a 100mV/g  $\pm 20\%$  additional output. The accelerometer frequency range is 1 Hz-10 kHz, maximum amplitude of 15 g-pk. Data collectors or analyzers can use this vibration signal for further analysis. This output is extended to the RVVO (Raw Vibration Velocity Output) option, which integrates the signal to a value of 100mV/IPS ( $\pm 20\%$ ).

**Figure 3 – RV and RVVO wiring**

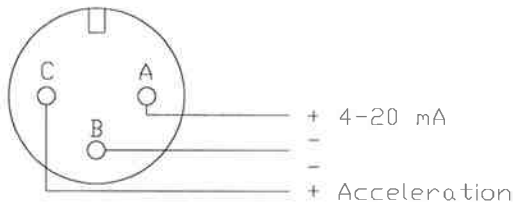

For integral cable sensors:

<b>RED</b>	<b>4-20mA Positive</b>
<b>BLACK</b>	<b>4-20mA Negative (same as green)</b>
<b>GREEN</b>	<b>-RV and RVVO negative (same as black)</b>
<b>WHITE</b>	<b>+RV and RVVO positive</b>

**Note:**

- The RV and RVVO Signal Negative has to be isolated from any grounding. If this terminal is grounded, the 4-20mA loop will short, causing no output.
- The RV and RVVO output signal is ideally suited for use with portable battery powered data collectors or analyzers.

**TO Option**

The TO (Temperature Output) option includes an additional independent 4-20mA output for temperature measurement. The temperature range is from -40°C to 125°C with an overall accuracy of  $\pm 5\%$ FSO. The imbedded temperature sensor monitors the environment internal to the sensor housing and is situated at approximately mid level.

**Figure 4 – TO wiring**

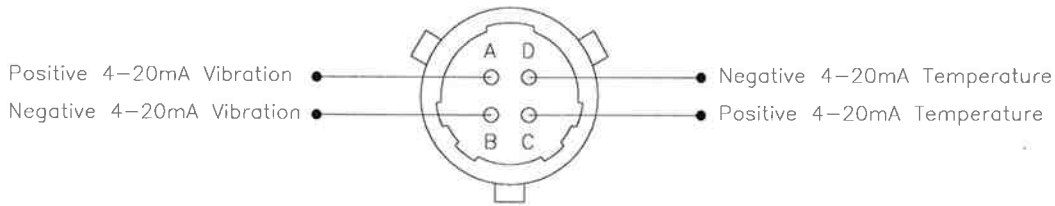

For integral cable sensors:

<b>RED</b>	<b>4-20mA Vibration Positive</b>
<b>BLACK</b>	<b>4-20mA Vibration Negative</b>
<b>GREEN</b>	<b>4-20mA Temperature Negative</b>
<b>WHITE</b>	<b>4-20mA Temperature Positive</b>

**Note:**

- The same power supply can be used for both 4-20mA loops. Connect the both positive terminals to directly to the power supply, then use the negative terminals for independent process loops.

## Installation

When choosing a mounting method, consider closely the advantages and disadvantages of each technique. Typical mounting types are stud, direct adhesive, adhesive mounting base and magnetic mounting base. Since the frequency response is limited to 1 kHz on the 640/641, any of the four methods can be used without seriously affecting the data values. The mounting method might affect some of the 645/646 series because of the increased frequency response.

### Direct Adhesive Mount Procedure

For restrictions of space or for convenience, most sensors (with the exception of integral stud models) can be adhesive-mounted directly to the machine surface.

**STEP 1** Prepare a smooth, flat mounting surface. A minimum surface finish of 63  $\mu\text{m}$  [0,00016 mm] generally works best.

**STEP 2** Place a small portion of adhesive on the underside of the sensor. Firmly press down on the top of the assembly to displace any adhesive. Be aware that excessive amounts of adhesive can make sensor removal difficult.

*Figure 5 – direct adhesive mounting*

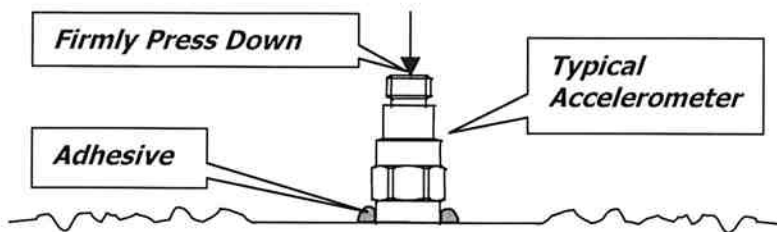

### Standard Stud Mount Procedure

This mounting technique requires smooth, flat contact surfaces for proper operation and is recommended for permanent and/or secure installations. Stud mounting is also recommended when testing at high frequencies.

**Note:** DO NOT attempt mounting on curved, rough or uneven surfaces, as the potential for misalignment and limited contact surface may significantly reduce the sensor's upper operating frequency range.

**Figure 6 – mounting surface preparation**

<u>1/4-28 Stud</u>	<u>1/4-28 Captive Screw</u>	
<b>A (in)</b>	0.250	0.250
<b>B (in)</b>	0.350	0.350
<b>Torque (ft-lb)</b>	2 to 5	2 to 5

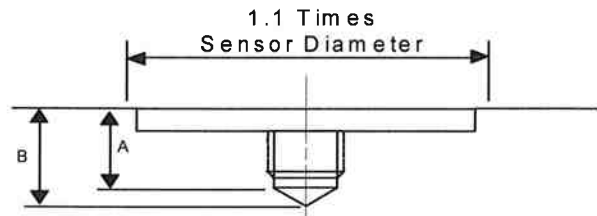

**STEP 1** First, prepare a smooth, flat mounting surface, and then drill and tap a mounting hole in the center of this area as shown in Figure 6. A precision-machined mounting surface with a minimum finish of 63  $\mu\text{in}$  [0,00016 mm] is recommended. (If it is not possible to properly prepare the machine surface, consider using an adhesive mounting pad as a possible alternative.) Inspect the area, checking that there are no burrs or other foreign particles interfering with the contact surface.

**STEP 2** Wipe clean the mounting surface and spread on a light film of grease, oil or similar coupling fluid prior to installation.

**Figure 7 – mounting surface lubrication**

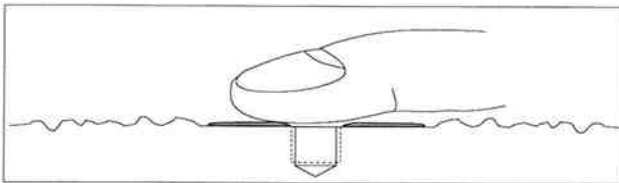

Adding a coupling fluid improves vibration transmissibility by filling small voids in the mounting surface and increasing the mounting stiffness. For semi-permanent mounting, substitute epoxy or another type of adhesive.

**STEP 3** **HAND-tighten** the sensor/mounting stud to the machine, then secure the sensor with a torque wrench to the mounting surface by applying the recommended mounting torque (see enclosed specification data sheet for proper mounting torque). It is important to use a torque wrench during this step. **Under-torquing the sensor may not adequately couple the device; over-torquing may result in stud failure and possibly permanent damage.**

### **Adhesive Stud Mount Procedure**

Adhesive mounting is often used for temporary installation or when the machine surface cannot be adequately prepared for stud mounting. Adhesives like hot glue or wax work well for temporary mounts; two-part epoxies and quick-bonding gels provide a more permanent mount.

---

**Note:** Adhesively mounted sensors often exhibit a reduction in high-frequency range. Generally, smooth surfaces and stiff adhesives provide the best frequency response. Contact the factory for recommended epoxies.

---

This method involves attaching a base to the machine surface, then securing the sensor to the base. This allows for easy removal of the accelerometer.

**STEP 1** Prepare a smooth, flat mounting surface. A minimum surface finish of 63  $\mu\text{in}$  [0,00016 mm] generally works best.

**STEP 2** Stud-mount the sensor to the appropriate adhesive mounting base according to the guidelines set forth in Steps 2 and 3 of the *Standard Stud Mount Procedure*.

**STEP 3** Place a small portion of adhesive on the underside of the mounting base. Firmly press down on the assembly to displace any extra adhesive remaining under the base.

**Figure 8 – mounting base: adhesive installation**

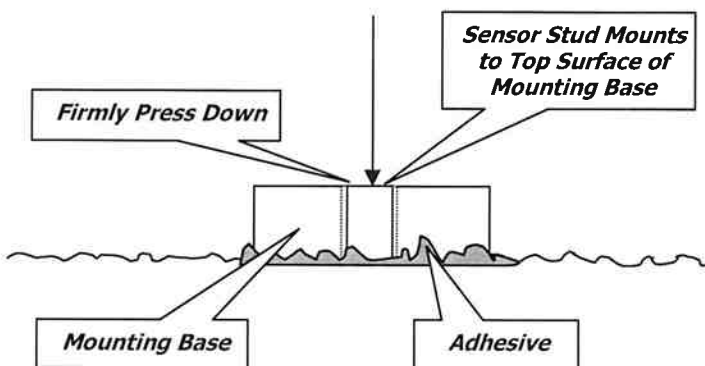

### Magnetic Mount Procedure

Magnetic mounting provides a convenient means for making portable measurements and is commonly used for machinery monitoring and other portable or trending applications.

---

**Note:** The correct magnet choice and an adequately prepared mounting surface is critical for obtaining reliable measurements, especially at high frequencies. Poor installations can cause as much as a 50% drop in the sensor frequency range.

---

**Not every magnet is suitable for all applications. For example, rare earth magnets are commonly used because of their high strength. Flat magnets work well on smooth, flat surfaces, while dual-rail magnets are required for curved surfaces. In the case of non-magnetic or rough surfaces, it is recommended that the user first weld, epoxy or otherwise adhere a steel mounting pad to the test surface. This provides a smooth and repeatable location for mounting.**

**Figure 9 – magnet types**

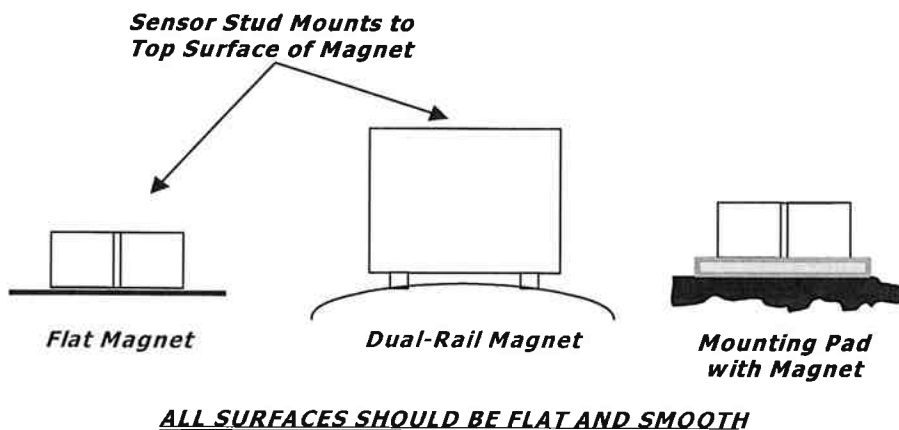

**STEP 1** After choosing the correct magnet type, inspect the unit, verifying that the mounting surfaces are flat and smooth.

**STEP 2** Stud-mount the accelerometer to the appropriate magnet according to the guidelines set forth in Steps 2 and 3 of the Standard Stud Mount Procedure.

**STEP 3** Prepare a smooth, flat mounting surface. A minimum surface finish of 63  $\mu\text{in}$  [0,00016 mm] generally works best. After cleaning the surface and checking for burrs, wipe on a light film of silicone grease, machine oil or similar-type coupling fluid.

**STEP 4** Mount the magnet/sensor assembly to the prepared test surface by gently "rocking" or "sliding" it into place.

---

**Note:** Magnetically mounting accelerometers carelessly has the potential to generate very high (and very damaging) g levels. To prevent damage, install the assembly gently. If unsure, please contact the factory for assistance.

---

## **Warning 1 – ESD sensitivity**

---

**The power supply/signal conditioner should not be opened by anyone other than qualified service personnel.** This product is intended for use by qualified personnel who recognize shock hazards and are familiar with the safety precautions required to avoid injury.

## **Warning 2 – ESD sensitivity**

---

This equipment is designed with user safety in mind; however, the protection provided by the equipment may be impaired if the equipment is used in a manner not specified by PCB Piezotronics, Inc.

## **Caution 1 – ESD sensitivity**

---

**Cables can kill your equipment.** High voltage electrostatic discharge (ESD) can damage electrical devices. Similar to a capacitor, a cable can hold a charge caused by triboelectric transfer, such as that which occurs in the following:

- *Laying on and moving across a rug,*
- *Any movement through air,*
- *The action of rolling out a cable, and/or*
- *Contact with a non-grounded person.*

### **The PCB solution for product safety:**

- *Connect the cables only with the AC power off.*
- *Temporarily "short" the end of the cable before attaching it to any signal input or output.*



## **Caution 2 – ESD sensitivity**

---

**ESD considerations should be made prior to performing any internal adjustments on the equipment.** Any piece of electronic equipment is vulnerable to ESD when opened for adjustments. Internal adjustments should therefore be done ONLY at an ESD-safe work area. Many products have ESD protection, but the level of protection may be exceeded by extremely high voltage.



## **Warranty**

---

IMI instrumentation is warranted against defective material and workmanship for 1 year unless otherwise expressly specified. Damage to instruments caused by incorrect power or misapplication, is not covered by warranty. *If there are any questions regarding power, intended application, or general usage, please consult with your local sales contact or distributor.* Batteries and other expendable hardware items are not covered by warranty.

## **Service**

---

Because of the sophisticated nature of IMI instrumentation, field repair is typically **NOT** recommended and may void any warranty. If factory service is required, return the instrumentation according to the "Return Procedure" stated below. *A repair and/or replacement quotation will be provided prior to servicing at no charge.* Before returning the unit, please consult a factory IMI applications engineer concerning the situation as certain problems can often be corrected with simple on-site procedures.

## **Return procedure**

---

*To expedite returned instrumentation, contact a factory IMI applications engineer for a RETURN MATERIAL AUTHORIZATION (RMA) NUMBER. Please have information available such as model and serial number. Also, to insure efficient service, provide a written description of the symptoms and problems with the equipment to a local sales representative or distributor, or contact IMI if none are located in your area.*

Customers outside the U.S. should consult their local IMI distributor for information on returning equipment. For exceptions, please contact the International Sales department at IMI to request shipping instructions and an RMA. For assistance, please call (716) 684-0003, or fax us at (716) 684-3823. You may also receive assistance via e-mail at [imi@pcb.com](mailto:imi@pcb.com) or visit our web site at [www.pcb.com](http://www.pcb.com).



## Customer Service

---

IMI, a division of PCB Piezotronics, guarantees **Total Customer Satisfaction**. If, at any time, for any reason, you are not completely satisfied with any IMI product, IMI will repair, replace, or exchange it at no charge. You may also choose to have your purchase price refunded.

IMI offers to all customers, at no charge, 24-hour phone support. This service makes product or application support available to our customers, day or night, seven days a week. When unforeseen problems or emergency situations arise, call the **IMI Hot Line at (716) 684-0003**, and an application specialist will assist you.



3425 Walden Avenue, Depew, NY 14043-2495  
Phone: (716) 684-0003 • USA Fax: (716) 684-3823 • INTL Fax: (716) 684-4703

*ICP® is a registered trademark of PCB Group, Incorporated,  
which uniquely identifies PCB sensors that incorporate built-in microelectronics.*

Model Number  
640B61

# LOOP POWERED, CURRENT OUTPUT, INDUSTRIAL VIBRATION SENSOR

Revision: B  
ECN #: 24962

Performance	ENGLISH	SI	
Measurement Range	0.0 to 1 in/s pk	0.0 to 25.4 mm/s pk	[1]
Output	4-20 mA	4-20 mA	
Frequency Range (± 10 %)	180 to 60,000 cpm	3 to 1 kHz	[2][3]
Broadband Resolution	0.005 in/s pk	0.13 mm/s pk	[4]
Non-Linearity	± 1 %	± 1 %	
<b>Environmental</b>			
Temperature Range	-40 to 185 °F	-40 to 85 °C	
<b>Electrical</b>			
Excitation Voltage	12 to 30 VDC	12 to 30 VDC	
Settling Time (within 2% of value)	<15 sec	<15 sec	
Electrical Isolation (Case)	>10 <sup>8</sup>	>10 <sup>8</sup>	
<b>Physical</b>			
Size (Hex x Height)	1.0 in x 4.2 in	25.4 mm x 107 mm	
Weight (without cable)	4.7 oz	131 gm	
Mounting Thread	1/4-28 UNF	Not Applicable	
Mounting Torque	3 to 5 ft-lb	4 to 7 N-m	
Sensing Element	Ceramic	Ceramic	
Sensing Geometry	Shear	Shear	
Housing Material	Stainless Steel	Stainless Steel	
Sealing	Welded Hermetic	Welded Hermetic	
Electrical Connector	Integral Armored Cable	Integral Armored Cable	
Electrical Connection Position	Top	Top	
Electrical Connections (Red)	4-20 mA Pos (+)	4-20 mA Pos (+)	
Electrical Connections (Blue)	4-20 mA Neg (-)	4-20 mA Neg (-)	
Cable Length	10 ft	3.0 m	
Cable Type	Polyurethane	Polyurethane	

**OPTIONAL VERSIONS**  
Optional versions have identical specifications and accessories as listed for the standard model except where noted below. More than one option may be used.

**EX** - ATEX or ATEX and CSA Hazardous Area Approval  
 Hazardous Area Approval EEx ia IIC T4, -40°C≤Tas80°C, II 1 G  
 Hazardous Area Approval EEx nL IIC T4, -40°C≤Tas80°C, II 3 G  
 Hazardous Area Approval DIV I, CL I, II, III, GRPS A-G, Exia, AExia, IIC T4  
 Hazardous Area Approval DIV II, CL I, GRPS A-D, ExnL, AExnA, IIC T4

**M** - Metric Mount  
 Supplied Accessory : Model M081A61 Mounting Stud 1/4-28 to M6 X 1 (1) replaces Model 081A40

**RV** - Buffered Analog Signal Output - 100 mV/g (±20%)  
 Electrical Connector Integral Armored Cable  
 Electrical Connections (Red) 4-20 mA Pos (+)  
 Electrical Connections (Black) 4-20 mA Neg (-)  
 Electrical Connections (White) Signal Output Pos  
 Electrical Connections (Green) Signal Output Neg

**NOTES:**  
 [1] Conversion Factor 1 in/sec = 0.0254 m/sec.  
 [2] Current will fluctuate at frequencies below 5 Hz.  
 [3] 1Hz = 60 cpm (cycles per minute).  
 [4] Typical.  
 [5] See PCB Declaration of Conformance PS039 or PS053 for details.

**SUPPLIED ACCESSORIES:**  
 Model 081A40 Mounting Stud (1)  
 Model ICS-4 NIST-traceable single-axis amplitude response calibration from 0 cpm (0 Hz) to upper 10% frequency for 4 - 20 mA output vibration sensor (1)

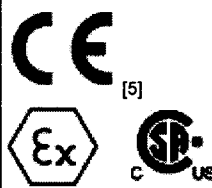

All specifications are at room temperature unless otherwise specified.  
 In the interest of constant product improvement, we reserve the right to change specifications without notice.  
 ICP® is a registered trademark of PCB Group, Inc.

Entered: <i>JFR</i>	Engineer: <i>MF</i>	Sales: <i>QMM</i>	Approved: <i>NS</i>	Spec Number:
Date: 9-22-04	Date: 9/22/04	Date: 9/22/06	Date: 9/22/06	27590

**IMI SENSORS**  
 A PCB PIEZOTRONICS DIV.  
 3425 Walden Avenue, Depew, NY 14043

Phone: 800-959-4464  
 Fax: 716-684-3823  
 E-Mail: imi@pcb.com

APPLICATION

NEXT ASS'Y	USED ON	VAR

REVISIONS

REV	DESCRIPTION	ECN	DATE	APP'D
NR	RELEASED TO DRAFTING		9/7/04	<i>cm</i>

27591

PCB Piezotronics Inc. claims proprietary rights in the information disclosed herein. Neither it nor any reproduction thereof will be disclosed to others without written consent of PCB Piezotronics Inc.

5.0[127]  
(TO TYPICAL  
BENDING RADIUS)

RED: POWER  
BLUE: RETURN

INTEGRAL ARMOR CABLE  
(MOLDED 2 CONDUCTOR  
SHIELDED CABLE)  
TERMINATING IN BLUNT CUT,  
10 FEET [3 METERS]  
FROM APPLICATION.

1.00[25.4] HEX

.050[1.27]

1/4-28 UNF-2B  
X .20[5.1] ▽

Ø.990[Ø25.2]  
TYP

641B62	0-2 IPS RMS, 10Hz-1kHz
641B61	0-1 IPS RMS, 10Hz-1kHz
641B60	0-0.5 IPS RMS, 10Hz-1kHz
640B62	0-2 IPS PK, 3Hz-1kHz
640B61	0-1 IPS PK, 3Hz-1kHz
640B60	0-0.5 IPS PK, 3Hz-1kHz
MODEL	DESCRIPTION

UNLESS SPECIFIED TOLERANCES

DIMENSIONS IN INCHES	DIMENSIONS IN MILLIMETERS [IN BRACKETS]
DECIMALS XX ±.03	DECIMALS X ±0.8
XXX ±.010	XX ±0.25
ANGLES ±2 DEGREES	ANGLES ±2 DEGREES

FILLETS AND RADII .003 - .005	FILLETS AND RADII [0.07 - 0.13]
----------------------------------	------------------------------------

DRAWN	<i>PCE</i>	9/14/04	MFG	<i>A. D.</i>	9/15/04
CHK'D	<i>cm</i>	9/14/04	ENGR	<i>MD</i>	9/15/04
APP'D	<i>U.F.</i>	9/14/04	SALES	<i>EG</i>	9/15/04

**PCB PIEZOTRONICS™**  
3425 WALDEN AVE. DEPEW, NY 14043  
(716) 684-0001 EMAIL: SALES@PCB.COM

TITLE  
OUTLINE DRAWING  
MODEL 640B6X, M, 641B6X, M  
4-20 mA ACCELEROMETER

CODE IDENT. NO. 52681  
DWG. NO. 27591

SCALE: 1.33X SHEET 1 OF 1