



Model 378C10
ICP Microphone System
Installation and Operating Manual

**This manual contains the 377C10, 426B03 installation and operating manuals that
comprise a Model 378C10 ICP Microphone System kit.**

**For assistance with the operation of this product,
contact PCB Piezotronics, Inc.**

Toll-free: 800-828-8840
24-hour SensorLine: 716-684-0001
Fax: 716-684-0987
E-mail: info@pcb.com
Web: www.pcb.com



The information contained in this document supersedes all similar information that may be found elsewhere in this manual.

Total Customer Satisfaction – PCB Piezotronics guarantees Total Customer Satisfaction. If, at any time, for any reason, you are not completely satisfied with any PCB product, PCB will repair, replace, or exchange it at no charge. You may also choose to have your purchase price refunded in lieu of the repair, replacement, or exchange of the product.

Service – Due to the sophisticated nature of the sensors and associated instrumentation provided by PCB Piezotronics, user servicing or repair is not recommended and, if attempted, may void the factory warranty. Routine maintenance, such as the cleaning of electrical connectors, housings, and mounting surfaces with solutions and techniques that will not harm the physical material of construction, is acceptable. Caution should be observed to insure that liquids are not permitted to migrate into devices that are not hermetically sealed. Such devices should only be wiped with a dampened cloth and never submerged or have liquids poured upon them.

Repair – In the event that equipment becomes damaged or ceases to operate, arrangements should be made to return the equipment to PCB Piezotronics for repair. User servicing or repair is not recommended and, if attempted, may void the factory warranty.

Calibration – Routine calibration of sensors and associated instrumentation is

recommended as this helps build confidence in measurement accuracy and acquired data. Equipment calibration cycles are typically established by the users own quality regimen. When in doubt about a calibration cycle, a good “rule of thumb” is to recalibrate on an annual basis. It is also good practice to recalibrate after exposure to any severe temperature extreme, shock, load, or other environmental influence, or prior to any critical test.

PCB Piezotronics maintains an ISO-9001 certified metrology laboratory and offers calibration services, which are accredited by A2LA to ISO/IEC 17025, with full traceability to N.I.S.T. In addition to the normally supplied calibration, special testing is also available, such as: sensitivity at elevated or cryogenic temperatures, phase response, extended high or low frequency response, extended range, leak testing, hydrostatic pressure testing, and others. For information on standard recalibration services or special testing, contact your local PCB Piezotronics distributor, sales representative, or factory customer service representative.

Returning Equipment – *Following these procedures will insure that your returned materials are handled in the most expedient manner.* Before returning any equipment to PCB Piezotronics, contact your local distributor, sales representative, or factory customer service representative to obtain a Return

Materials Authorization (RMA) Number. This RMA number should be clearly marked on the outside of all package(s) and on the packing list(s) accompanying the shipment. A detailed account of the nature of the problem(s) being experienced with the equipment should also be included inside the package(s) containing any returned materials.

A Purchase Order, included with the returned materials, will expedite the turn-around of serviced equipment. It is recommended to include authorization on the Purchase Order for PCB to proceed with any repairs, as long as they do not exceed 50% of the replacement cost of the returned item(s). PCB will provide a price quotation or replacement recommendation for any item whose repair costs would exceed 50% of replacement cost, or any item that is not economically feasible to repair. For routine calibration services, the Purchase Order should include authorization to proceed and return at current pricing, which can be obtained from a factory customer service representative.

Warranty – All equipment and repair services provided by PCB Piezotronics, Inc. are covered by a limited warranty against defective material and workmanship for a period of one year from date of original purchase. Contact

PCB for a complete statement of our warranty. Expendable items, such as batteries and mounting hardware, are not covered by warranty. Mechanical damage to equipment due to improper use is not covered by warranty. Electronic circuitry failure caused by the introduction of unregulated or improper excitation power or electrostatic discharge is not covered by warranty.

Contact Information – International customers should direct all inquiries to their local distributor or sales office. A complete list of distributors and offices can be found at www.pcb.com. Customers within the United States may contact their local sales representative or a factory customer service representative. A complete list of sales representatives can be found at www.pcb.com. Toll-free telephone numbers for a factory customer service representative, in the division responsible for this product, can be found on the title page at the front of this manual. Our ship to address and general contact numbers are:

PCB Piezotronics, Inc.
3425 Walden Ave.
Depew, NY 14043 USA
Toll-free: (800) 828-8840
24-hour SensorLineSM: (716) 684-0001
Website: www.pcb.com
E-mail: info@pcb.com

PCB Piezotronics Inc. claims proprietary rights in the information disclosed hereon. Neither it nor any reproduction thereof will be disclosed to others without the written consent of PCB Piezotronics Inc.

57747

REVISIONS		
REV	DESCRIPTION	DIN
A	ADDED ADDITIONAL VENT HOLE	43127

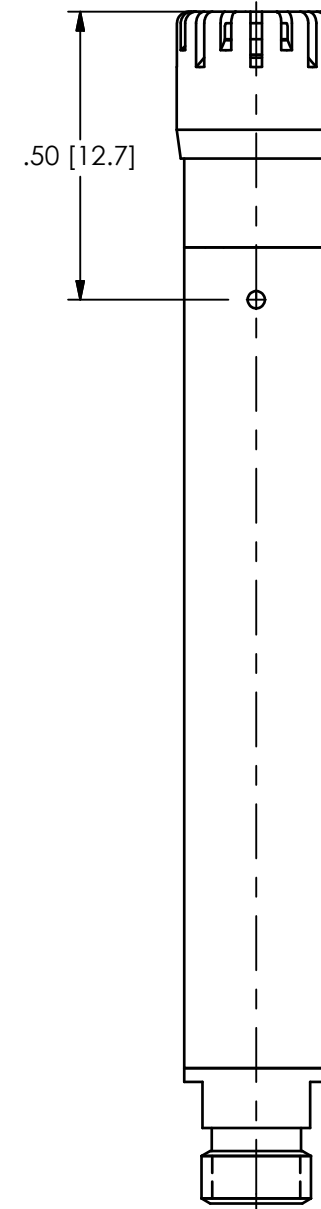
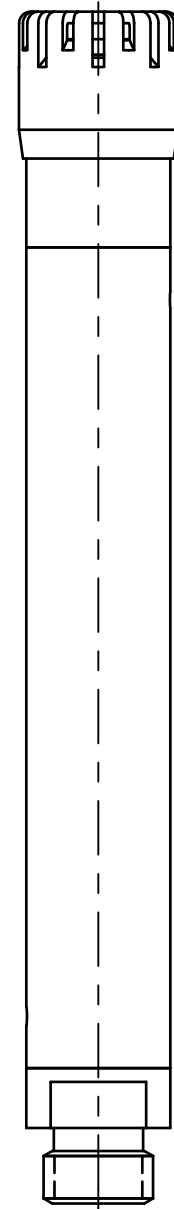
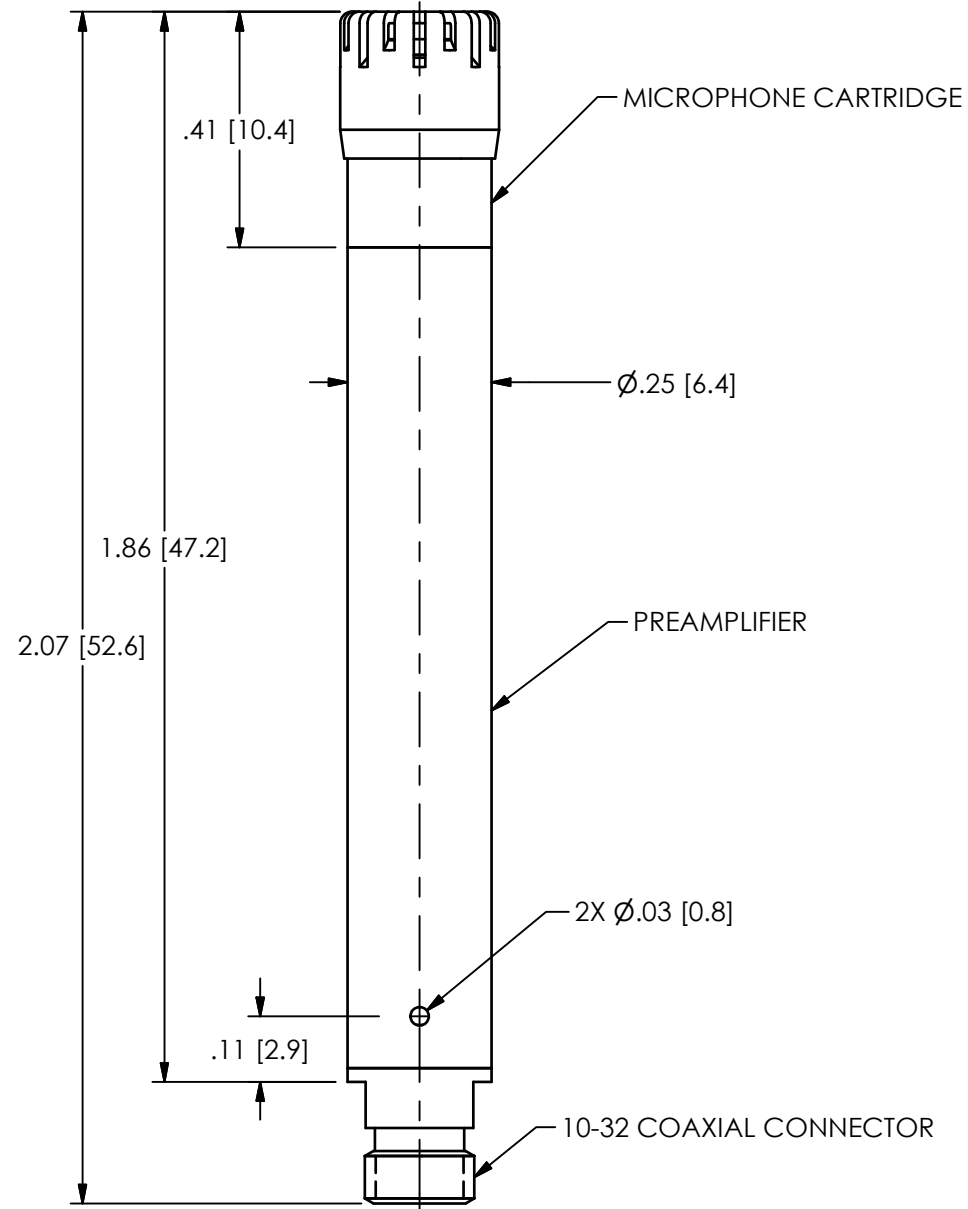
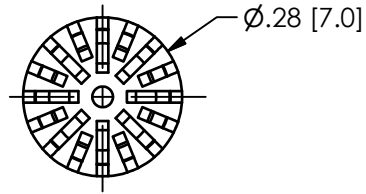

UNLESS OTHERWISE SPECIFIED TOLERANCES ARE:		DRAWN		CHECKED		ENGINEER	
DIMENSIONS IN INCHES	DIMENSIONS IN MILLIMETERS [IN BRACKETS]	JDM	7/7/14	ECB	7/7/14	NJL	7/7/14
DECIMALS XX ±.03 XXX ±.010	DECIMALS X ±0.8 XX ±0.25	TITLE OUTLINE DRAWING 1/4" ICP MICROPHONE SYSTEM					
ANGLES ± 2 DEGREES	ANGLES ± 2 DEGREES						
FILLETS AND RADII .003 - .005	FILLETS AND RADII 0.07 - 0.13	CODE IDENT. NO. 52681		DWG. NO. 57747		3425 WALDEN AVE. DEPEW, NY 14043 (716) 684-0001 E-MAIL: sales@pcb.com	
		SCALE: 3X		SHEET 1 OF 1			

jmorawski 09:01 7/8/2014

PCB Piezotronics Inc. claims proprietary rights in the information disclosed hereon. Neither it nor any reproduction thereof will be disclosed to others without the written consent of PCB Piezotronics Inc.

57747

REVISIONS		
REV	DESCRIPTION	DIN
A	ADDED ADDITIONAL VENT HOLE	43127

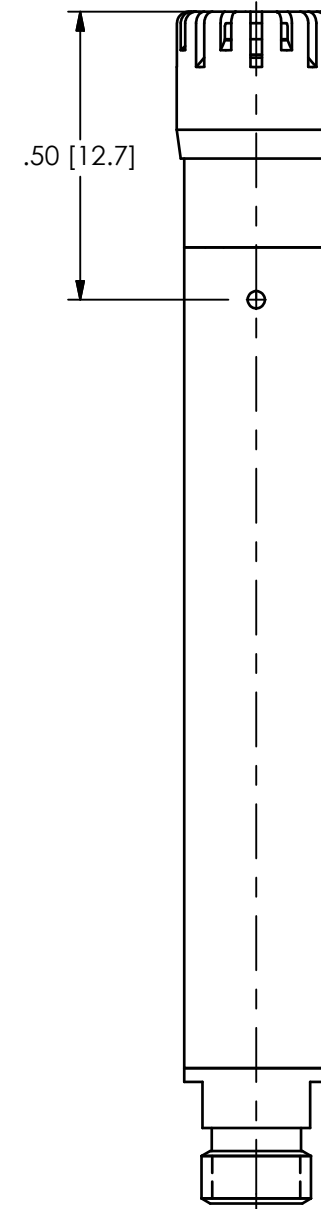
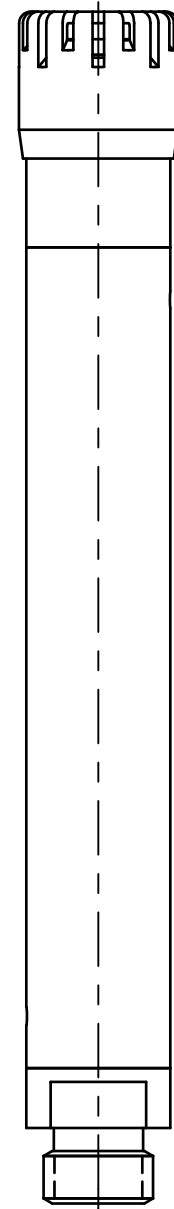
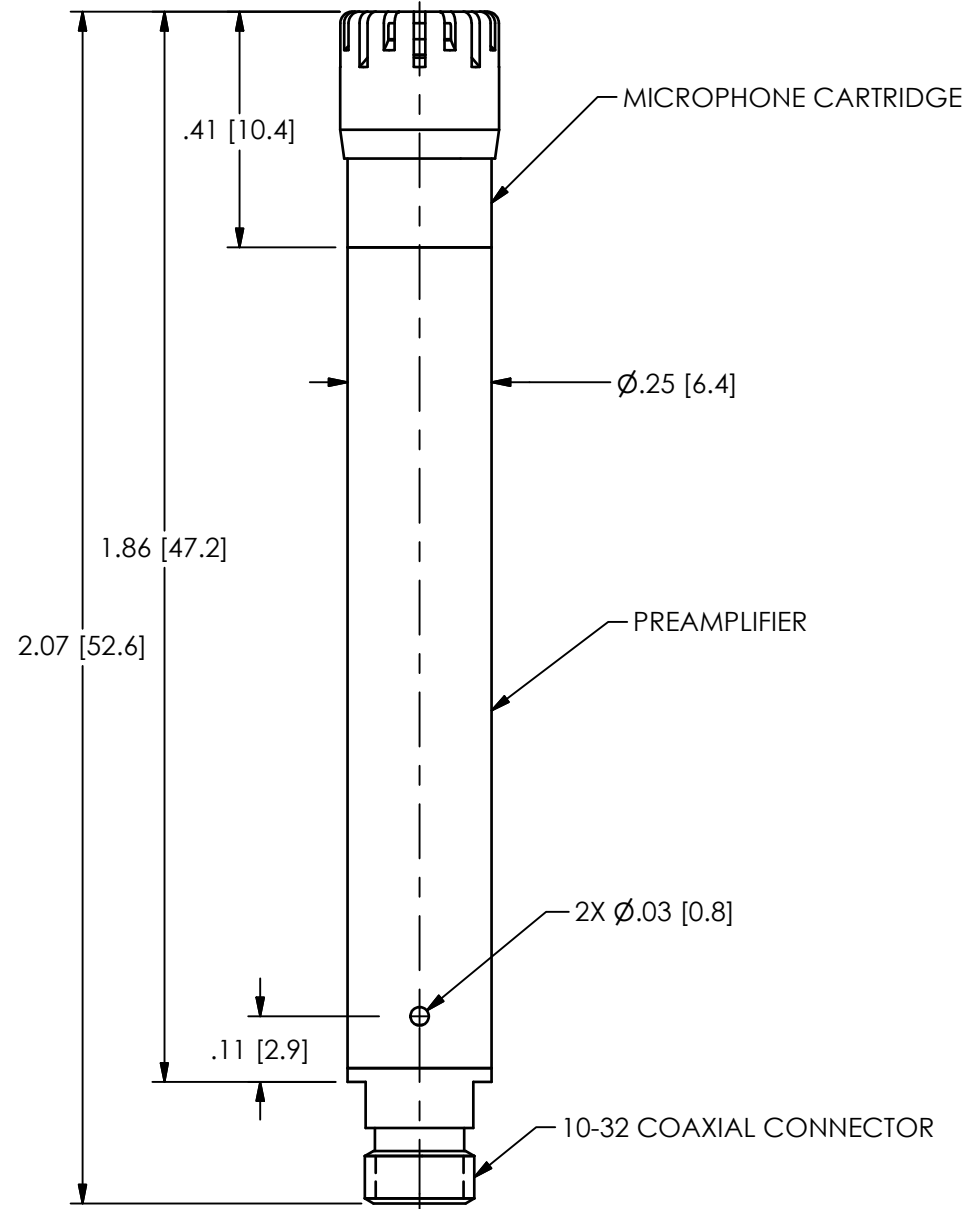
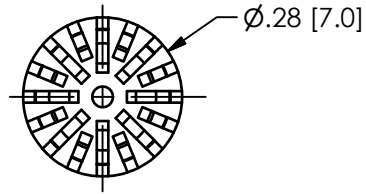

UNLESS OTHERWISE SPECIFIED TOLERANCES ARE:		DRAWN		CHECKED		ENGINEER	
DIMENSIONS IN INCHES	DIMENSIONS IN MILLIMETERS [IN BRACKETS]	JDM	7/7/14	ECB	7/7/14	NJL	7/7/14
DECIMALS XX ±.03 XXX ±.010	DECIMALS X ±0.8 XX ±0.25	TITLE OUTLINE DRAWING 1/4" ICP MICROPHONE SYSTEM					
ANGLES ± 2 DEGREES	ANGLES ± 2 DEGREES						
FILLETS AND RADII .003 - .005	FILLETS AND RADII 0.07 - 0.13	CODE IDENT. NO. 52681		DWG. NO. 57747		3425 WALDEN AVE. DEPEW, NY 14043 (716) 684-0001 E-MAIL: sales@pcb.com	
		SCALE: 3X		SHEET 1 OF 1			

jmorawski 09:01 7/8/2014



Model 377C10
Precision Condenser Microphone
Installation and Operating Manual

**For assistance with the operation of this product,
contact PCB Piezotronics, Inc.**

Toll-free: 800-828-8840
24-hour SensorLine: 716-684-0001
Fax: 716-684-0987
E-mail: info@pcb.com
Web: www.pcb.com



The information contained in this document supersedes all similar information that may be found elsewhere in this manual.

Total Customer Satisfaction – PCB Piezotronics guarantees Total Customer Satisfaction. If, at any time, for any reason, you are not completely satisfied with any PCB product, PCB will repair, replace, or exchange it at no charge. You may also choose to have your purchase price refunded in lieu of the repair, replacement, or exchange of the product.

Service – Due to the sophisticated nature of the sensors and associated instrumentation provided by PCB Piezotronics, user servicing or repair is not recommended and, if attempted, may void the factory warranty. Routine maintenance, such as the cleaning of electrical connectors, housings, and mounting surfaces with solutions and techniques that will not harm the physical material of construction, is acceptable. Caution should be observed to insure that liquids are not permitted to migrate into devices that are not hermetically sealed. Such devices should only be wiped with a dampened cloth and never submerged or have liquids poured upon them.

Repair – In the event that equipment becomes damaged or ceases to operate, arrangements should be made to return the equipment to PCB Piezotronics for repair. User servicing or repair is not recommended and, if attempted, may void the factory warranty.

Calibration – Routine calibration of sensors and associated instrumentation is

recommended as this helps build confidence in measurement accuracy and acquired data. Equipment calibration cycles are typically established by the users own quality regimen. When in doubt about a calibration cycle, a good “rule of thumb” is to recalibrate on an annual basis. It is also good practice to recalibrate after exposure to any severe temperature extreme, shock, load, or other environmental influence, or prior to any critical test.

PCB Piezotronics maintains an ISO-9001 certified metrology laboratory and offers calibration services, which are accredited by A2LA to ISO/IEC 17025, with full traceability to N.I.S.T. In addition to the normally supplied calibration, special testing is also available, such as: sensitivity at elevated or cryogenic temperatures, phase response, extended high or low frequency response, extended range, leak testing, hydrostatic pressure testing, and others. For information on standard recalibration services or special testing, contact your local PCB Piezotronics distributor, sales representative, or factory customer service representative.

Returning Equipment – *Following these procedures will insure that your returned materials are handled in the most expedient manner.* Before returning any equipment to PCB Piezotronics, contact your local distributor, sales representative, or factory customer service representative to obtain a Return

Materials Authorization (RMA) Number. This RMA number should be clearly marked on the outside of all package(s) and on the packing list(s) accompanying the shipment. A detailed account of the nature of the problem(s) being experienced with the equipment should also be included inside the package(s) containing any returned materials.

A Purchase Order, included with the returned materials, will expedite the turn-around of serviced equipment. It is recommended to include authorization on the Purchase Order for PCB to proceed with any repairs, as long as they do not exceed 50% of the replacement cost of the returned item(s). PCB will provide a price quotation or replacement recommendation for any item whose repair costs would exceed 50% of replacement cost, or any item that is not economically feasible to repair. For routine calibration services, the Purchase Order should include authorization to proceed and return at current pricing, which can be obtained from a factory customer service representative.

Warranty – All equipment and repair services provided by PCB Piezotronics, Inc. are covered by a limited warranty against defective material and workmanship for a period of one year from date of original purchase. Contact

PCB for a complete statement of our warranty. Expendable items, such as batteries and mounting hardware, are not covered by warranty. Mechanical damage to equipment due to improper use is not covered by warranty. Electronic circuitry failure caused by the introduction of unregulated or improper excitation power or electrostatic discharge is not covered by warranty.

Contact Information – International customers should direct all inquiries to their local distributor or sales office. A complete list of distributors and offices can be found at www.pcb.com. Customers within the United States may contact their local sales representative or a factory customer service representative. A complete list of sales representatives can be found at www.pcb.com. Toll-free telephone numbers for a factory customer service representative, in the division responsible for this product, can be found on the title page at the front of this manual. Our ship to address and general contact numbers are:

PCB Piezotronics, Inc.
3425 Walden Ave.
Depew, NY 14043 USA
Toll-free: (800) 828-8840
24-hour SensorLineSM: (716) 684-0001
Website: www.pcb.com
E-mail: info@pcb.com

PCB PIEZOTRONICS ^{INC.}

VIBRATION DIVISION

PRODUCT GUIDE

377 SERIES MICROPHONES

426 SERIES PREAMPLIFIERS

Contents:

Introduction.....	1.0
Standards.....	2.0
Setting up a Microphone Measurement System	3.0
Taking Measurements.....	4.0
Accessories	5.0
Maintenance.....	6.0
Calibration.....	7.0
Warranty & Service	8.0



1.0 Introduction

Thank you for your purchase of a PCB high quality microphone. These microphones offer highly accurate and reliable acoustic measurements and are typically used in research and design applications. They are accurate enough for laboratory usage, yet rugged enough for field-testing.

Sound, which may or may not be detected by the human ear, is of interest in a wide variety of areas from the development of consumer products to research in acoustics. The typical audible range of a healthy human ear is 20 to 20,000 Hz. Sound in this range can be both pleasing to the ear, as in music, or noise that is undesirable. Even beyond these frequencies, many are interested in measuring sound. In all these cases, the instrument typically used to make such measurements is the microphone, which is designed, like the human ear, to transform pressure oscillations into a corresponding voltage oscillation.

2.0 Standards

Prior to selecting an acoustical instrument, the consumer should determine whether there are certain standards that the product must comply with, for the application in which the product will be used. Whether for legal purposes, or for quality assurance programs, these standards will help determine the quality, accuracy and consistency of the products. Standards have been set for sound level meters, calibrators, microphones, or other related components, that correspond to the performance requirements, dimensions and characteristics of acoustical components. The most popular organizations for these standards are the American National Standards Institute (ANSI) and the International Electrotechnical Commission (IEC). IEC 1094-4 establishes specifications on the mechanical dimensions and certain electroacoustic characteristics for working standard microphones. The particular standards that relate to these microphones are given in the performance specification sheet supplied with each microphone.

3.0 Setting up a Microphone Measurement System

After the proper selection of the microphone has been determined, the corresponding preamplifier, cabling, power supplies, signal conditioning and data acquisitions selections are ready to be installed. Not

all of these components are required for all test set-ups. The figure below shows the typical set-up for an externally polarized and a prepolarized microphone system.

A prepolarized microphone can be used with a standard Microphone Power Supply that is designed for externally powered microphones, and its preamplifier, provided that you set the supply voltage to zero.



Externally Polarized Microphone System



Prepolarized Microphone System

4.0 Taking Measurements

To calculate the pressure measured by the microphone from the output voltage signal. The sensitivity of a microphone is typically measured at 250 Hz.

$$\text{Pressure (Pa)} = \text{Voltage (mV)} / \text{Sensitivity (mV/Pa)}.$$

The lowest amplitude that a healthy human ear can detect is 20 millionths of a Pascal (20 μ Pa). Another scale that is more commonly used to describe sound pressure level is the decibel (dB). To convert the output voltage signal (measured in V_{rms}) to sound pressure level (measured in decibels),

$$SPL = \left(20 \text{Log} \left(\frac{V_{rms}}{S P_{ref}} \right) \right) \text{dB}$$

where S is the sensitivity of the microphone in mV/Pa, and P_{ref} is the reference pressure in air, which is 20×10^{-6} Pa. The decibel scale is logarithmic and more closely matches the response reactions of the human ear to the pressure fluctuations. Some examples of typical sound pressure levels are shown in the table below.

dB	Pressure	Example
0	0.00002 Pa	Threshold of Hearing
60	0.02 Pa	Business Office
80	0.2 Pa	Shop Noise
94	1 Pa	Large Truck
100	2 Pa	Jackhammer
120	20 Pa	Airplane Take-Off
140	200 Pa	Threshold of Pain

At very high-pressure amplitudes, the diaphragm will start to distort the measured sound pressure. The maximum rated sound pressure level of a microphone is expressed as the amplitude at which the Total Harmonic Distortion (THD) reaches a specified amount, typically 3% THD. It is important to note that the highest sound pressure level that one will be able to measure with a microphone system may be limited by other parts of the system, such as the preamplifier, signal conditioner, or instrumentation. Conversely, the Cartridge Thermal Noise (CTN) specification provides the lowest measurable sound pressure level that can be detected above the electrical noise, inherent within the microphone.

Temperature and pressure will have an effect on the sensitivity of a microphone. These effects can be accounted for by adjusting the microphone sensitivity using the specified coefficients given for each microphone model. Simply calculate the difference in temperature and ambient pressure from those recorded during calibration and multiply this value by the proper coefficient to determine the sensitivity offset. In most cases, the offset will be very small and is therefore unnecessary.

5.0 Accessories

Transducer Electronics Data Sheet (TEDS)

Preamplifiers incorporating TEDS are devices that have a built in read/write memory that contains relevant information about the sensor and its use. Information includes manufacturer name, model number, serial number, sensitivity, etc. The operation of TEDS devices is defined by IEEE P1451.4. A TEDS microphone system includes a mated preamplifier with contains the TEDS memory programmed with both the microphone and preamplifier information. This is particularly helpful when using large channel count systems and array set-up.

A-Weight Inline Filter

The inline filter is used in conjunction with an ICP™ preamplifier to provide A-weighting for acoustical measurements. The filter's frequency response is weighted according to the A-weighting filter portion of both ANSI S1.4 and IEC 60651 Type 1 Sound Level Meter Standards. ICP™ signal conditioners of 4mA or greater are recommended when using inline filters.

Windscreens and Nose cones

Wind induced noise can be reduced by using a windscreen. This can offer some protection against dust particles and mechanical damage. In the presence of high-speed airflow from a well-defined direction, such as wind tunnels, a nose cone is recommended. When using windscreens and noise cones, the frequency response of the microphone will be attenuated at higher frequencies.

Clamps and stands

When holding a microphone in place it is important to minimize the influence of the stand on the sound being measured. This can be accomplished by the use of low profile stands and clamps that are available.

Cables and Electronics

PCB carries LEMO® cables as well as coaxial cables with BNC and 10-32 connectors. Traditional externally polarized microphone power supplies along with a variety of ICP™ signal conditioners are available that will fit almost any need.

6.0 Maintenance

Keep the microphone and preamplifier assembled while preparing for testing. Dust and dirt may adversely affect the microphone and preamplifier performance. If you should get dirt or dust on the microphone insulator or inside the connection area of the preamplifier, blow clean, dry air into the unit in order to remove the dust. With proper maintenance, your measurement devices should provide stable and

accurate results for years to come. Users need to be aware of both the operating and storage temperature of the microphones. If operated or stored in extreme conditions, permanent damage may occur. Frequent calibration is recommended in this environment.

Microphones are very stable over long periods of time provided that they are handled properly. Components of the microphone are fragile and can get damaged by misuse. The diaphragm is made up of a very thin metal material that should be kept clean of dust, dirt, moisture and any type of imperfection (scratch, dent, etc.) The protective grid cap is designed to protect the diaphragm with little effect on the sound pressure. We do not recommend that you ever remove the grid cap, if possible. We do not recommend cleaning the microphone and if you take the precautionary measures to keep it clean and dry, it should not be necessary. In the event that you absolutely must take off the grid cap and clean the microphone diaphragm, we recommend using a soft cotton swab with a little alcohol. Make sure that the alcohol fully dries before supplying power to, and using the microphone. Do not touch the microphones diaphragm with your fingers or let it come in contact with any sharp or pointed object.

7.0 Calibration

PCB offers recalibration services for our precision microphones, as well as units produced by other manufacturers. Our internal metrology laboratory is certified to ISO 9001, accredited by A2LA to ANSI/IEC 17025 and ANSI/NC SL Z540-1, complies with ISO 10012-1 (and former MIL-STD-45662A), and uses equipment directly traceable to NIST. Our investment in equipment, traceability and conformance to industry standards ensures accurate calibration against relevant specifications. We also carry a line of acoustic calibrators that can be used to calibrate microphone sensitivity on-site as needed.

8.0 Warranty and Service

All equipment and repair services provided by PCB Piezotronics, Inc. are covered by a warranty against defective material and workmanship under a **Total Customer Satisfaction** policy. If, at any time, for any reason, you are not completely satisfied with any PCB product, PCB will repair, replace, or exchange it at no charge. You may also choose to have your purchase price refunded. See the supplemental sheet, contained with this manual, for information on our service, repair and return policies, procedures and instructions. When unexpected problems arise, call our 24-Hour SensorLineSM (716-684-0001) to speak with a factory representative. Contact PCB for a complete statement of our warranty.

3425 Walden Avenue, Depew, NY 14043-2495

E-Mail: vibration@pcb.com

Website: www.pcb.com

24-hour SensorLineSM: 716-684-0001

Fax: 716-6853886

Vibration Division toll-free: 888-684-0013

A PCB GROUP COMPANY

ISO 9001 CERTIFIED

A2LA ACCREDITED to ISO 17025

© 2004 PCB Group, Inc. In the interest of constant product improvement, specifications are subject to change without notice. PCB and ICP are registered trademarks of PCB Group, Inc. Sensor Line is a service mark of PCB Group, Inc. All other trademarks are properties of the respective owners.

Manual Number: 27042
Manual Revision: B
ECO 28030



VIB-377 Manual – 1/08
Printed in the U.S.A.

Model Number 377C10	PRECISION CONDENSER MICROPHONE		Revision: G ECN #: 42896											
Performance Nominal Microphone Diameter Frequency Response Characteristic Open Circuit Sensitivity Open Circuit Sensitivity(± 3 dB) Frequency Range(± 2 dB) Lower Limiting Frequency(-3 dB) Resonant Frequency(90° Phase Shift) Inherent Noise	<u>ENGLISH</u> 1/4" Pressure 1.0 mV/Pa -60 dB re 1 V/Pa 4 to 70,000 Hz 0.25 to 3.0 Hz 65,000 Hz <35 dB(A) re 20 μPa	<u>SI</u> 1/4" Pressure 1.0 mV/Pa -60 dB re 1 V/Pa 4 to 70,000 Hz 0.25 to 3.0 Hz 65,000 Hz <35 dB(A) re 20 μPa	OPTIONAL VERSIONS Optional versions have identical specifications and accessories as listed for the standard model except where noted below. More than one option may be used.											
Environmental Temperature Range(Operating) Temperature Coefficient of Sensitivity(+14 to +122°F (-10 to +50°C)) Static Pressure Coefficient Humidity Coefficient of Sensitivity(0 to 100%, non-condensing) Influence of Axial Vibration(0.1g (1 m/s ²))	>174 dB re 20 μPa -40 to +248 °F 0.004 dB/°F -0.003 dB/kPa ± 0.0012 dB/%RH 66 dB re 20 μPa	>174 dB re 20 μPa -40 to +120 °C 0.007 dB/°C -0.003 dB/kPa ± 0.0012 dB/%RH 66 dB re 20 μPa	NOTES: [1] Typical. [2] Prepolarized [3] re 250 Hz											
Electrical Capacitance(Polarized) Polarization Voltage	5 pF 0 V	5 pF 0 V	SUPPLIED ACCESSORIES: Model ACS-20 Calibration of Precision Condensator Microphones (1)											
Physical Housing Material Venting Mounting Thread(Preamplifier) Mounting Thread(Grid) Size (Diameter x Height)(with grid) Size (Diameter x Height)(without grid) Weight	Stainless Alloy Rear 0.2244 - 60 UNS 0.25 - 60 UNS 0.28 in x 0.41 in 0.25 in x 0.36 in 0.06 oz	Stainless Alloy Rear 5.7 mm - 60 UNS 6.35 mm - 60 UNS 7.0 mm x 10.5 mm 6.4 mm x 9.1 mm 1.8 gm	<table border="1" style="width: 100%; border-collapse: collapse;"> <tr> <td style="width: 15%;">Entered: AP</td> <td style="width: 15%;">Engineer: MJN</td> <td style="width: 15%;">Sales: MV</td> <td style="width: 15%;">Approved: MT</td> <td style="width: 40%;">Spec Number:</td> </tr> <tr> <td>Date: 5/7/2014</td> <td>Date: 5/7/2014</td> <td>Date: 5/7/2014</td> <td>Date: 5/7/2014</td> <td style="text-align: center;">40215</td> </tr> </table>		Entered: AP	Engineer: MJN	Sales: MV	Approved: MT	Spec Number:	Date: 5/7/2014	Date: 5/7/2014	Date: 5/7/2014	Date: 5/7/2014	40215
Entered: AP	Engineer: MJN	Sales: MV	Approved: MT	Spec Number:										
Date: 5/7/2014	Date: 5/7/2014	Date: 5/7/2014	Date: 5/7/2014	40215										
<i>All specifications are at room temperature unless otherwise specified. In the interest of constant product improvement, we reserve the right to change specifications without notice.</i> ICP® is a registered trademark of PCB Group, Inc.			 3425 Walden Avenue, Depew, NY 14043 Phone: 716-684-0001 Fax: 716-684-0987 E-Mail: info@pcb.com											

2

1

PCB Piezotronics Inc. claims proprietary rights in the information disclosed hereon. Neither it nor any reproduction thereof will be disclosed to others without the written consent of PCB Piezotronics Inc.

REVISIONS

REV	DESCRIPTION	DIN
A	UPDATED DESIGN	40589

31223

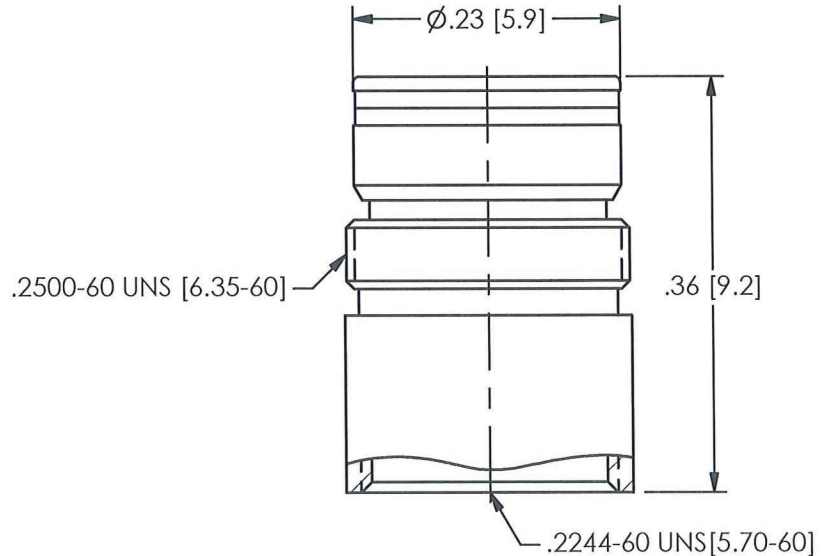
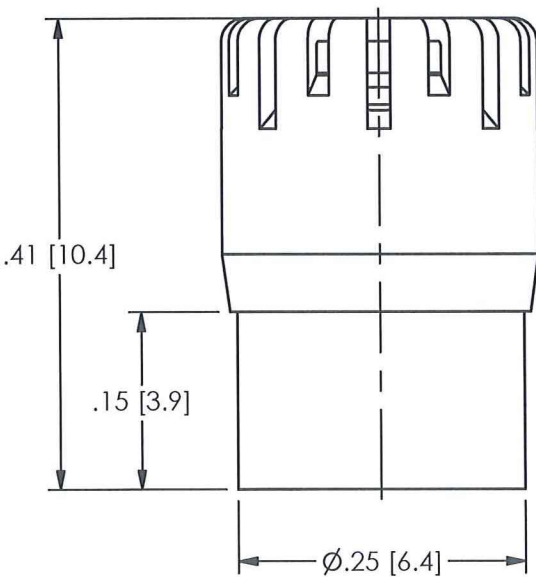
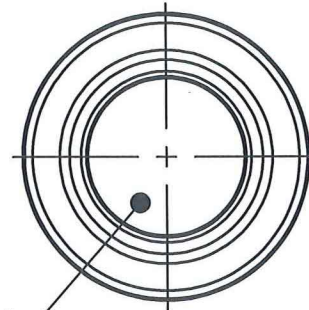
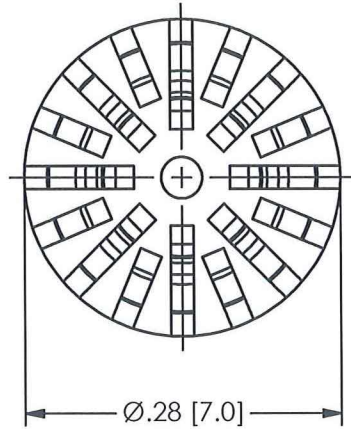

SHOWN WITH GRID CAP

SHOWN WITHOUT GRID CAP

UNLESS OTHERWISE SPECIFIED TOLERANCES ARE:		DRAWN	CHECKED	ENGINEER	<p>3425 WALDEN AVE. DEPEW, NY 14043 (716) 684-0001 E-MAIL: sales@pcb.com</p>	
DIMENSIONS IN INCHES	DIMENSIONS IN MILLIMETERS [IN BRACKETS]	JDM	2/13/13	MJN		2/13/13
DECIMALS XX ±.03 XXX ±.010	DECIMALS X ±0.8 XX ±0.25	TITLE				CODE IDENT. NO. 52681
ANGLES ± 2 DEGREES	ANGLES ± 2 DEGREES	OUTLINE DRAWING 1/4" PRE-POLARIZED MICROPHONES				DWG. NO. 31223
FILLETS AND RADII .003 - .005	FILLETS AND RADII 0.07 - 0.13				SCALE: 6X	SHEET 1 OF 1

2

1



Model 426B03
Microphone Preamplifier
Installation and Operating Manual

**For assistance with the operation of this product,
contact PCB Piezotronics, Inc.**

Toll-free: 800-828-8840
24-hour SensorLine: 716-684-0001
Fax: 716-684-0987
E-mail: info@pcb.com
Web: www.pcb.com



The information contained in this document supersedes all similar information that may be found elsewhere in this manual.

Total Customer Satisfaction – PCB Piezotronics guarantees Total Customer Satisfaction. If, at any time, for any reason, you are not completely satisfied with any PCB product, PCB will repair, replace, or exchange it at no charge. You may also choose to have your purchase price refunded in lieu of the repair, replacement, or exchange of the product.

Service – Due to the sophisticated nature of the sensors and associated instrumentation provided by PCB Piezotronics, user servicing or repair is not recommended and, if attempted, may void the factory warranty. Routine maintenance, such as the cleaning of electrical connectors, housings, and mounting surfaces with solutions and techniques that will not harm the physical material of construction, is acceptable. Caution should be observed to insure that liquids are not permitted to migrate into devices that are not hermetically sealed. Such devices should only be wiped with a dampened cloth and never submerged or have liquids poured upon them.

Repair – In the event that equipment becomes damaged or ceases to operate, arrangements should be made to return the equipment to PCB Piezotronics for repair. User servicing or repair is not recommended and, if attempted, may void the factory warranty.

Calibration – Routine calibration of sensors and associated instrumentation is

recommended as this helps build confidence in measurement accuracy and acquired data. Equipment calibration cycles are typically established by the users own quality regimen. When in doubt about a calibration cycle, a good “rule of thumb” is to recalibrate on an annual basis. It is also good practice to recalibrate after exposure to any severe temperature extreme, shock, load, or other environmental influence, or prior to any critical test.

PCB Piezotronics maintains an ISO-9001 certified metrology laboratory and offers calibration services, which are accredited by A2LA to ISO/IEC 17025, with full traceability to N.I.S.T. In addition to the normally supplied calibration, special testing is also available, such as: sensitivity at elevated or cryogenic temperatures, phase response, extended high or low frequency response, extended range, leak testing, hydrostatic pressure testing, and others. For information on standard recalibration services or special testing, contact your local PCB Piezotronics distributor, sales representative, or factory customer service representative.

Returning Equipment – *Following these procedures will insure that your returned materials are handled in the most expedient manner.* Before returning any equipment to PCB Piezotronics, contact your local distributor, sales representative, or factory customer service representative to obtain a Return

Materials Authorization (RMA) Number. This RMA number should be clearly marked on the outside of all package(s) and on the packing list(s) accompanying the shipment. A detailed account of the nature of the problem(s) being experienced with the equipment should also be included inside the package(s) containing any returned materials.

A Purchase Order, included with the returned materials, will expedite the turn-around of serviced equipment. It is recommended to include authorization on the Purchase Order for PCB to proceed with any repairs, as long as they do not exceed 50% of the replacement cost of the returned item(s). PCB will provide a price quotation or replacement recommendation for any item whose repair costs would exceed 50% of replacement cost, or any item that is not economically feasible to repair. For routine calibration services, the Purchase Order should include authorization to proceed and return at current pricing, which can be obtained from a factory customer service representative.

Warranty – All equipment and repair services provided by PCB Piezotronics, Inc. are covered by a limited warranty against defective material and workmanship for a period of one year from date of original purchase. Contact

PCB for a complete statement of our warranty. Expendable items, such as batteries and mounting hardware, are not covered by warranty. Mechanical damage to equipment due to improper use is not covered by warranty. Electronic circuitry failure caused by the introduction of unregulated or improper excitation power or electrostatic discharge is not covered by warranty.

Contact Information – International customers should direct all inquiries to their local distributor or sales office. A complete list of distributors and offices can be found at www.pcb.com. Customers within the United States may contact their local sales representative or a factory customer service representative. A complete list of sales representatives can be found at www.pcb.com. Toll-free telephone numbers for a factory customer service representative, in the division responsible for this product, can be found on the title page at the front of this manual. Our ship to address and general contact numbers are:

PCB Piezotronics, Inc.
3425 Walden Ave.
Depew, NY 14043 USA
Toll-free: (800) 828-8840
24-hour SensorLineSM: (716) 684-0001
Website: www.pcb.com
E-mail: info@pcb.com

PCB PIEZOTRONICS ^{INC.} **VIBRATION DIVISION**

PRODUCT GUIDE **377 SERIES MICROPHONES** **426 SERIES PREAMPLIFIERS**

Contents:

Introduction.....	1.0
Standards.....	2.0
Setting up a Microphone Measurement System	3.0
Taking Measurements.....	4.0
Accessories	5.0
Maintenance.....	6.0
Calibration.....	7.0
Warranty & Service	8.0



1.0 Introduction

Thank you for your purchase of a PCB high quality microphone. These microphones offer highly accurate and reliable acoustic measurements and are typically used in research and design applications. They are accurate enough for laboratory usage, yet rugged enough for field-testing.

Sound, which may or may not be detected by the human ear, is of interest in a wide variety of areas from the development of consumer products to research in acoustics. The typical audible range of a healthy human ear is 20 to 20,000 Hz. Sound in this range can be both pleasing to the ear, as in music, or noise that is undesirable. Even beyond these frequencies, many are interested in measuring sound. In all these cases, the instrument typically used to make such measurements is the microphone, which is designed, like the human ear, to transform pressure oscillations into a corresponding voltage oscillation.

2.0 Standards

Prior to selecting an acoustical instrument, the consumer should determine whether there are certain standards that the product must comply with, for the application in which the product will be used. Whether for legal purposes, or for quality assurance programs, these standards will help determine the quality, accuracy and consistency of the products. Standards have been set for sound level meters, calibrators, microphones, or other related components, that correspond to the performance requirements, dimensions and characteristics of acoustical components. The most popular organizations for these standards are the American National Standards Institute (ANSI) and the International Electrotechnical Commission (IEC). IEC 1094-4 establishes specifications on the mechanical dimensions and certain electroacoustic characteristics for working standard microphones. The particular standards that relate to these microphones are given in the performance specification sheet supplied with each microphone.

3.0 Setting up a Microphone Measurement System

After the proper selection of the microphone has been determined, the corresponding preamplifier, cabling, power supplies, signal conditioning and data acquisitions selections are ready to be installed. Not

all of these components are required for all test set-ups. The figure below shows the typical set-up for an externally polarized and a prepolarized microphone system.

A prepolarized microphone can be used with a standard Microphone Power Supply that is designed for externally powered microphones, and its preamplifier, provided that you set the supply voltage to zero.



Externally Polarized Microphone System



Prepolarized Microphone System

4.0 Taking Measurements

To calculate the pressure measured by the microphone from the output voltage signal. The sensitivity of a microphone is typically measured at 250 Hz.

$$Pressure (Pa) = Voltage (mV) / Sensitivity (mV/Pa).$$

The lowest amplitude that a healthy human ear can detect is 20 millionths of a Pascal (20 μ Pa). Another scale that is more commonly used to describe sound pressure level is the decibel (dB). To convert the output voltage signal (measured in V_{rms}) to sound pressure level (measured in decibels),

$$SPL = \left(20 \text{Log} \left(\frac{V_{rms}}{S P_{ref}} \right) \right) dB$$

where S is the sensitivity of the microphone in mV/Pa, and P_{ref} is the reference pressure in air, which is 20×10^{-6} Pa. The decibel scale is logarithmic and more closely matches the response reactions of the human ear to the pressure fluctuations. Some examples of typical sound pressure levels are shown in the table below.

dB	Pressure	Example
0	0.00002 Pa	Threshold of Hearing
60	0.02 Pa	Business Office
80	0.2 Pa	Shop Noise
94	1 Pa	Large Truck
100	2 Pa	Jackhammer
120	20 Pa	Airplane Take-Off
140	200 Pa	Threshold of Pain

At very high-pressure amplitudes, the diaphragm will start to distort the measured sound pressure. The maximum rated sound pressure level of a microphone is expressed as the amplitude at which the Total Harmonic Distortion (THD) reaches a specified amount, typically 3% THD. It is important to note that the highest sound pressure level that one will be able to measure with a microphone system may be limited by other parts of the system, such as the preamplifier, signal conditioner, or instrumentation. Conversely, the Cartridge Thermal Noise (CTN) specification provides the lowest measurable sound pressure level that can be detected above the electrical noise, inherent within the microphone.

Temperature and pressure will have an effect on the sensitivity of a microphone. These effects can be accounted for by adjusting the microphone sensitivity using the specified coefficients given for each microphone model. Simply calculate the difference in temperature and ambient pressure from those recorded during calibration and multiply this value by the proper coefficient to determine the sensitivity offset. In most cases, the offset will be very small and is therefore unnecessary.

5.0 Accessories

Transducer Electronics Data Sheet (TEDS)

Preamplifiers incorporating TEDS are devices that have a built in read/write memory that contains relevant information about the sensor and its use. Information includes manufacturer name, model number, serial number, sensitivity, etc. The operation of TEDS devices is defined by IEEE P1451.4. A TEDS microphone system includes a mated preamplifier with contains the TEDS memory programmed with both the microphone and preamplifier information. This is particularly helpful when using large channel count systems and array set-up.

A-Weight Inline Filter

The inline filter is used in conjunction with an ICP™ preamplifier to provide A-weighting for acoustical measurements. The filter's frequency response is weighted according to the A-weighting filter portion of both ANSI S1.4 and IEC 60651 Type 1 Sound Level Meter Standards. ICP™ signal conditioners of 4mA or greater are recommended when using inline filters.

Windscreens and Nose cones

Wind induced noise can be reduced by using a windscreen. This can offer some protection against dust particles and mechanical damage. In the presence of high-speed airflow from a well-defined direction, such as wind tunnels, a nose cone is recommended. When using windscreens and noise cones, the frequency response of the microphone will be attenuated at higher frequencies.

Clamps and stands

When holding a microphone in place it is important to minimize the influence of the stand on the sound being measured. This can be accomplished by the use of low profile stands and clamps that are available.

Cables and Electronics

PCB carries LEMO® cables as well as coaxial cables with BNC and 10-32 connectors. Traditional externally polarized microphone power supplies along with a variety of ICP™ signal conditioners are available that will fit almost any need.

6.0 Maintenance

Keep the microphone and preamplifier assembled while preparing for testing. Dust and dirt may adversely affect the microphone and preamplifier performance. If you should get dirt or dust on the microphone insulator or inside the connection area of the preamplifier, blow clean, dry air into the unit in order to remove the dust. With proper maintenance, your measurement devices should provide stable and

accurate results for years to come. Users need to be aware of both the operating and storage temperature of the microphones. If operated or stored in extreme conditions, permanent damage may occur. Frequent calibration is recommended in this environment.

Microphones are very stable over long periods of time provided that they are handled properly. Components of the microphone are fragile and can get damaged by misuse. The diaphragm is made up of a very thin metal material that should be kept clean of dust, dirt, moisture and any type of imperfection (scratch, dent, etc.) The protective grid cap is designed to protect the diaphragm with little effect on the sound pressure. We do not recommend that you ever remove the grid cap, if possible. We do not recommend cleaning the microphone and if you take the precautionary measures to keep it clean and dry, it should not be necessary. In the event that you absolutely must take off the grid cap and clean the microphone diaphragm, we recommend using a soft cotton swab with a little alcohol. Make sure that the alcohol fully dries before supplying power to, and using the microphone. Do not touch the microphones diaphragm with your fingers or let it come in contact with any sharp or pointed object.

7.0 Calibration

PCB offers recalibration services for our precision microphones, as well as units produced by other manufacturers. Our internal metrology laboratory is certified to ISO 9001, accredited by A2LA to ANSI/IEC 17025 and ANSI/NC SL Z540-1, complies with ISO 10012-1 (and former MIL-STD-45662A), and uses equipment directly traceable to NIST. Our investment in equipment, traceability and conformance to industry standards ensures accurate calibration against relevant specifications. We also carry a line of acoustic calibrators that can be used to calibrate microphone sensitivity on-site as needed.

8.0 Warranty and Service

All equipment and repair services provided by PCB Piezotronics, Inc. are covered by a warranty against defective material and workmanship under a **Total Customer Satisfaction** policy. If, at any time, for any reason, you are not completely satisfied with any PCB product, PCB will repair, replace, or exchange it at no charge. You may also choose to have your purchase price refunded. See the supplemental sheet, contained with this manual, for information on our service, repair and return policies, procedures and instructions. When unexpected problems arise, call our 24-Hour SensorLineSM (716-684-0001) to speak with a factory representative. Contact PCB for a complete statement of our warranty.

3425 Walden Avenue, Depew, NY 14043-2495

E-Mail: vibration@pcb.com

Website: www.pcb.com

24-hour SensorLineSM: 716-684-0001

Fax: 716-6853886

Vibration Division toll-free: 888-684-0013

A PCB GROUP COMPANY

ISO 9001 CERTIFIED

A2LA ACCREDITED to ISO 17025

© 2004 PCB Group, Inc. In the interest of constant product improvement, specifications are subject to change without notice. PCB and ICP are registered trademarks of PCB Group, Inc. Sensor Line is a service mark of PCB Group, Inc. All other trademarks are properties of the respective owners.

Manual Number: 27042
Manual Revision: B
ECO 28030



VIB-377 Manual – 1/08
Printed in the U.S.A.

	<u>ENGLISH</u>	<u>SI</u>	
Performance			
Nominal Microphone Diameter	1/4"	1/4"	
Gain	-0.19 dB	-0.19 dB	[1][2]
Frequency Response(± 0.1 dB)(re 1 kHz)	5 to 126,000 Hz	5 to 126,000 Hz	
Frequency Response(± 0.2 dB)(re 1 kHz)	3.2 to 126,000 Hz	3.2 to 126,000 Hz	
Frequency Response(-3 dB)(re 1 kHz)	<0.7 Hz	<0.7 Hz	
Phase Linearity(<1 °)	63 to 20,000 Hz	63 to 20,000 Hz	
Electrical Noise(A-weight)	<3.2 µV	<3.2 µV	[2]
Electrical Noise(A-weight)	1.9 µV	1.9 µV	[1][2]
Electrical Noise(Flat 20 Hz to 20 kHz)	<5.6 µV	<5.6 µV	[2]
Electrical Noise(Flat 20 Hz to 20 kHz)	3.4 µV	3.4 µV	[1][2]
Distortion(3 V rms input at 1 kHz)	<-70 dB	<-70 dB	
Output Slew Rate	2 V/µS	2 V/µS	[1]
TEDS Compliant	Yes	Yes	[3]
Environmental			
Temperature Range(Operating)	-40 to 158 °F	-40 to 70 °C	
Temperature Range(Storage)	-40 to 185 °F	-40 to 85 °C	
Temperature Response	<0.03 dB	<0.03 dB	
Humidity Range(Non-Condensing)	0 to 95 %RH	0 to 95 %RH	
Humidity Sensitivity	<0.03 dB	<0.03 dB	
Electrical			
Excitation Voltage	20 to 32 VDC	20 to 32 VDC	
Constant Current Excitation	2 to 20 mA	2 to 20 mA	
Impedance(Input)	2x10 ¹⁰ Ohm	2x10 ¹⁰ Ohm	[1]
Capacitance(Input)	0.15 pF	0.15 pF	[1]
Output Bias Voltage	10 to 14 VDC	10 to 14 VDC	
Impedance(Output)	<50 Ohm	<50 Ohm	
Output Voltage(Maximum)	± 8 V	± 8 V	[1]
Physical			
Housing Material	Stainless Steel	Stainless Steel	
Size (Diameter x Length)	0.25 in x 1.74 in	6.4 mm x 44.2 mm	
Weight	0.21 oz	6 gm	
Electrical Connector	10-32 Coaxial Jack	10-32 Coaxial Jack	
Mounting Thread(Microphone to Preamplifier)	0.2244 - 60 UNS	5.7 mm - 60 UNS	

OPTIONAL VERSIONS

Optional versions have identical specifications and accessories as listed for the standard model except where noted below. More than one option may be used.

NOTES:

[1] Typical.
 [2] Measured with an 18 pF reference microphone.
 [3] TEDS Capable Digital Memory and Communication, compliant with IEEE P1451.4
 [4] See PCB Declaration of Conformance PS076 for details.

SUPPLIED ACCESSORIES:
 Model ERC-16 Calibration of microphone preamplifier (1)

Entered: AP	Engineer: MT	Sales: MV	Approved: MT	Spec Number:
Date: 6/2/2014	Date: 6/2/2014	Date: 6/2/2014	Date: 6/2/2014	22760



All specifications are at room temperature unless otherwise specified.
 In the interest of constant product improvement, we reserve the right to change specifications without notice.
 ICP® is a registered trademark of PCB Group, Inc.

PCB PIEZOTRONICS™
 3425 Walden Avenue, Depew, NY 14043

Phone: 716-684-0001
 Fax: 716-684-0987
 E-Mail: info@pcb.com

PCB Piezotronics Inc. claims proprietary rights in the information disclosed hereon. Neither it nor any reproduction thereof will be disclosed to others without the written consent of PCB Piezotronics Inc.

23553

REVISIONS

REV	DESCRIPTION	DIN
B	ADDED ADDITIONAL VENT HOLE	43127

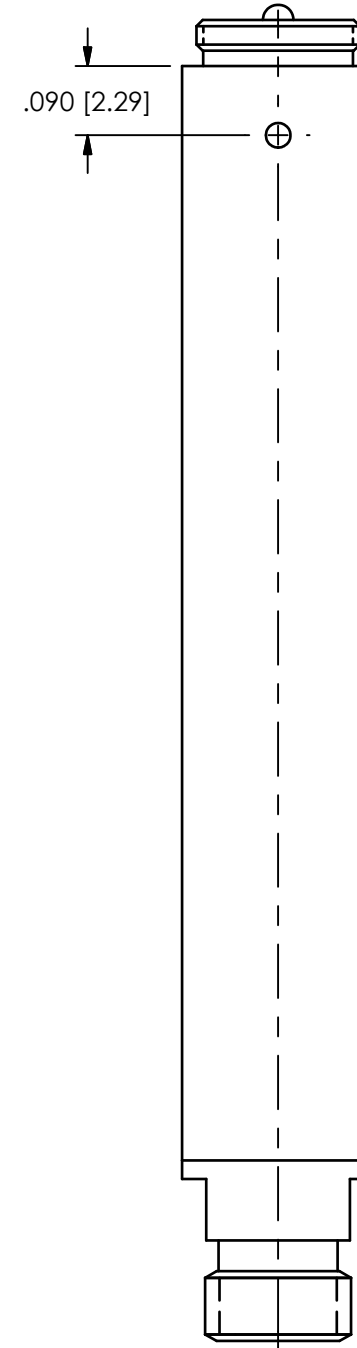
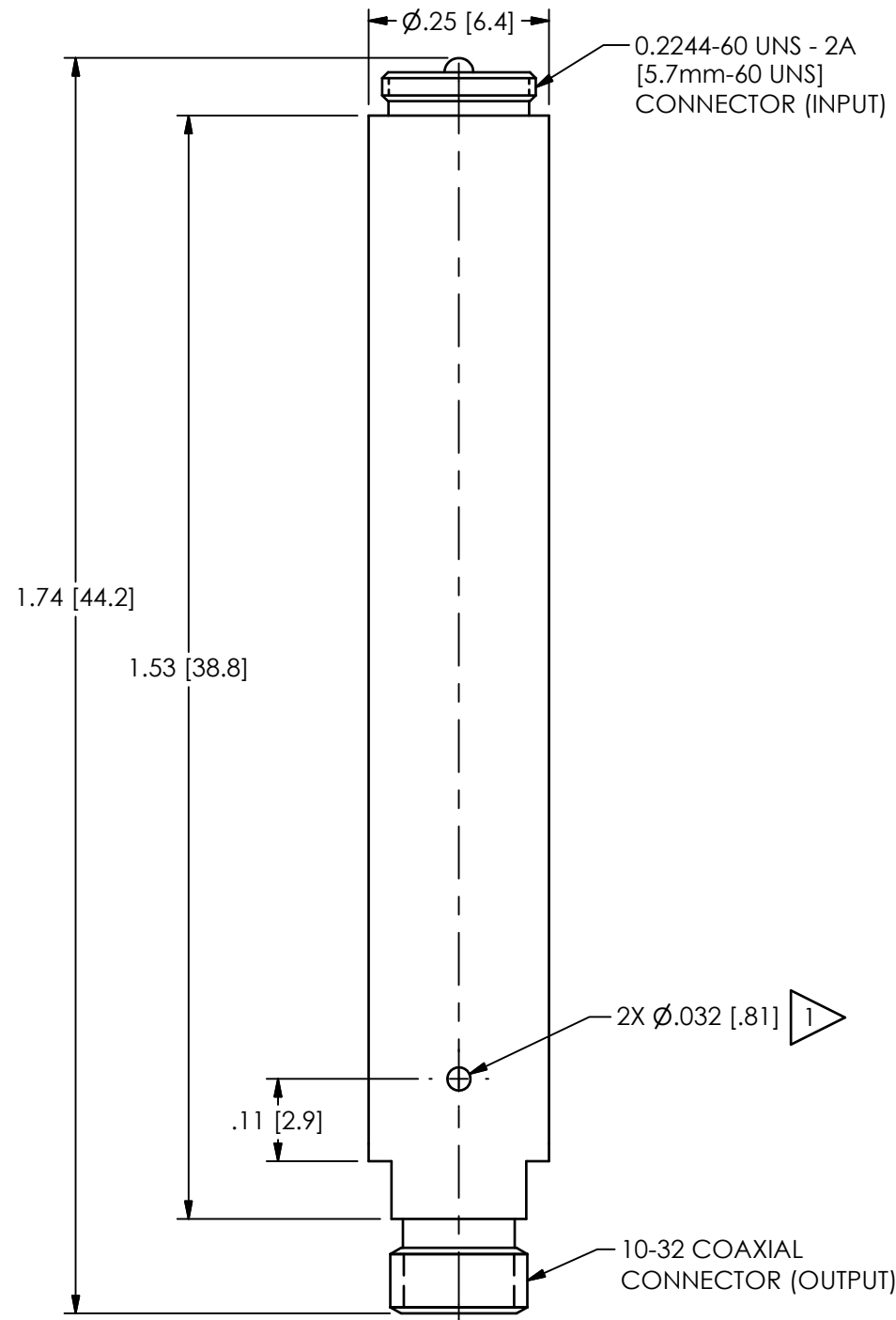

1 VENT HOLES PRESENT ON MODEL 426B03 ONLY.

UNLESS OTHERWISE SPECIFIED TOLERANCES ARE:		DRAWN		CHECKED		ENGINEER			
DIMENSIONS IN INCHES	DIMENSIONS IN MILLIMETERS [IN BRACKETS]	JDM	7/7/14	ECB	7/7/14	NJL	7/7/14		
DECIMALS XX ±.03 XXX ±.010	DECIMALS X ±0.8 XX ±0.25	TITLE OUTLINE DRAWING 1/4" MICROPHONE PREAMPLIFIER						CODE IDENT. NO. 52681	DWG. NO. 23553
ANGLES ± 2 DEGREES	ANGLES ± 2 DEGREES							SCALE: 4X	SHEET 1 OF 1
FILLETS AND RADII .003 - .005	FILLETS AND RADII 0.07 - 0.13							3425 WALDEN AVE. DEPEW, NY 14043 (716) 684-0001 E-MAIL: sales@pcb.com	