



Model 213B

Force ring, 20k lb comp., 18 pC/lb, charge output

Installation and Operating Manual

**For assistance with the operation of this product,
contact PCB Piezotronics, Inc.**

**Toll-free: 800-828-8840
24-hour SensorLine: 716-684-0001
Fax: 716-684-0987
E-mail: info@pcb.com
Web: www.pcb.com**



The information contained in this document supersedes all similar information that may be found elsewhere in this manual.

Total Customer Satisfaction – PCB Piezotronics guarantees Total Customer Satisfaction. If, at any time, for any reason, you are not completely satisfied with any PCB product, PCB will repair, replace, or exchange it at no charge. You may also choose to have your purchase price refunded in lieu of the repair, replacement, or exchange of the product.

Service – Due to the sophisticated nature of the sensors and associated instrumentation provided by PCB Piezotronics, user servicing or repair is not recommended and, if attempted, may void the factory warranty. Routine maintenance, such as the cleaning of electrical connectors, housings, and mounting surfaces with solutions and techniques that will not harm the physical material of construction, is acceptable. Caution should be observed to insure that liquids are not permitted to migrate into devices that are not hermetically sealed. Such devices should only be wiped with a dampened cloth and never submerged or have liquids poured upon them.

Repair – In the event that equipment becomes damaged or ceases to operate, arrangements should be made to return the equipment to PCB Piezotronics for repair. User servicing or repair is not recommended and, if attempted, may void the factory warranty.

Calibration – Routine calibration of sensors and associated instrumentation is

recommended as this helps build confidence in measurement accuracy and acquired data. Equipment calibration cycles are typically established by the users own quality regimen. When in doubt about a calibration cycle, a good “rule of thumb” is to recalibrate on an annual basis. It is also good practice to recalibrate after exposure to any severe temperature extreme, shock, load, or other environmental influence, or prior to any critical test.

PCB Piezotronics maintains an ISO-9001 certified metrology laboratory and offers calibration services, which are accredited by A2LA to ISO/IEC 17025, with full traceability to N.I.S.T. In addition to the normally supplied calibration, special testing is also available, such as: sensitivity at elevated or cryogenic temperatures, phase response, extended high or low frequency response, extended range, leak testing, hydrostatic pressure testing, and others. For information on standard recalibration services or special testing, contact your local PCB Piezotronics distributor, sales representative, or factory customer service representative.

Returning Equipment – *Following these procedures will insure that your returned materials are handled in the most expedient manner.* Before returning any equipment to PCB Piezotronics, contact your local distributor, sales representative, or factory customer service representative to obtain a Return

Materials Authorization (RMA) Number. This RMA number should be clearly marked on the outside of all package(s) and on the packing list(s) accompanying the shipment. A detailed account of the nature of the problem(s) being experienced with the equipment should also be included inside the package(s) containing any returned materials.

A Purchase Order, included with the returned materials, will expedite the turn-around of serviced equipment. It is recommended to include authorization on the Purchase Order for PCB to proceed with any repairs, as long as they do not exceed 50% of the replacement cost of the returned item(s). PCB will provide a price quotation or replacement recommendation for any item whose repair costs would exceed 50% of replacement cost, or any item that is not economically feasible to repair. For routine calibration services, the Purchase Order should include authorization to proceed and return at current pricing, which can be obtained from a factory customer service representative.

Warranty – All equipment and repair services provided by PCB Piezotronics, Inc. are covered by a limited warranty against defective material and workmanship for a period of one year from date of original purchase. Contact

PCB for a complete statement of our warranty. Expendable items, such as batteries and mounting hardware, are not covered by warranty. Mechanical damage to equipment due to improper use is not covered by warranty. Electronic circuitry failure caused by the introduction of unregulated or improper excitation power or electrostatic discharge is not covered by warranty.

Contact Information – International customers should direct all inquiries to their local distributor or sales office. A complete list of distributors and offices can be found at www.pcb.com. Customers within the United States may contact their local sales representative or a factory customer service representative. A complete list of sales representatives can be found at www.pcb.com. Toll-free telephone numbers for a factory customer service representative, in the division responsible for this product, can be found on the title page at the front of this manual. Our ship to address and general contact numbers are:

PCB Piezotronics, Inc.
3425 Walden Ave.
Depew, NY 14043 USA
Toll-free: (800) 828-8840
24-hour SensorLineSM: (716) 684-0001
Website: www.pcb.com
E-mail: info@pcb.com

1.0 INTRODUCTION

PCB Quartz Force Sensors are designed to measure rapidly changing compression, tensile, and impact forces for wide dynamic ranges from 10 to 100,000 lbs (44.48 N to 444.8 kN). Most sensors feature all welded construction. Voltage mode versions for low impedance output are also available.

PCB manufactures various standard sensor configurations that allow ease of installation for nearly any application. These configurations include general purpose, axial, impact, rings, 3-component, and links. In addition, custom units can be manufactured for specific requirements

Refer to the installation/outline drawing and specification sheet at the front of this manual for details and dimensions of the particular sensor model number(s) purchased. The following pages give a brief description of the various sensor series available, recommended mounting procedures, operation and recommended calibration.

If you wish to learn more about sensors with built-in microelectronic circuitry, known as ICP® sensors, consult PCB's "General Guide to ICP® Instrumentation", a brochure outlining the technical specifics associated with piezoelectric force sensors. Topics covered include charge versus voltage mode systems, sensor time constants, effect of discharge time constant on low frequency response, and power requirements.

Should questions arise regarding the operation or characteristics of the Charge Mode Force Sensor products as outlined in this manual, feel free to contact an experienced applications engineer from the Force/Torque Division of PCB toll-free 888-684-0004.

2.0 DESCRIPTION

IMPACT

Series 210 Impact Sensors are designed to measure compression and impact forces from 10 to 50,000 lbs (44.48 N to 222.4 kN). The flat sensing surface is located on the top of the sensor and is designed to measure force as it is applied axially to the sensor.

As highlighted in **Figure 1**, compression forces directed against the sensing surface produce a negative-going output. This force-directed input and corresponding output apply to all charge mode sensors. (If desired, adding the prefix "P" to a model number upon order can indicate polarity reversal).

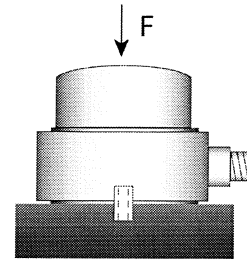

Free Standing
Impact Installation

Figure 1 - Series 210 Charge Mode Impact Sensor

RINGS

Series 211B to 217B Ring Sensors are designed to measure compression forces from 10 to 100,000 lbs (44.48 N to 444.8 kN).

Each sensor is provided with a calibration sheet reflecting the sensitivity of the sensor using the supplied mounting stud. If the stud cannot be used for installation, PCB can provide a custom calibration using the desired bolt for accurate sensitivity readings. Using a different mounting stud will result in a sensitivity that differs from the original calibration. Refer to **Section 3** for recommended force ring mounting and preload requirements.

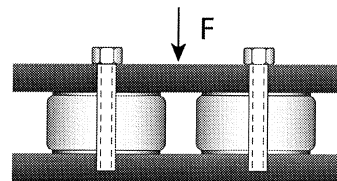

Platform
Installation

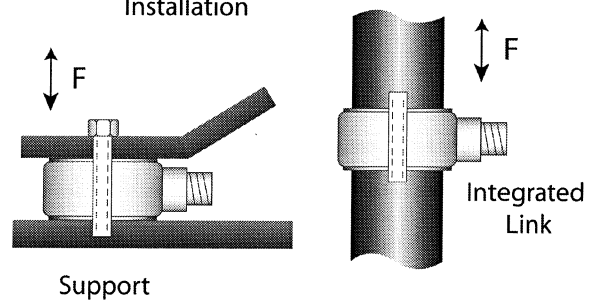

Support

Integrated
Link

Figure 2 -Series 211B to 217B Force Ring Sensor

GENERAL PURPOSE - RADIAL

Model 218C General Purpose Sensor is designed to measure compression and impact forces from 10 to 5,000 lbs (44.48 N to 22.24 kN). Tension forces can be measured to 500 lbs. (2.224 kN). Model 084A03, a convex stainless steel cap with integral 10-32 mounting stud, is supplied for impact measurements. Polyimide film tape covers the cap surface to

reduce high-frequency ringing associated with metal-to-metal impacts.

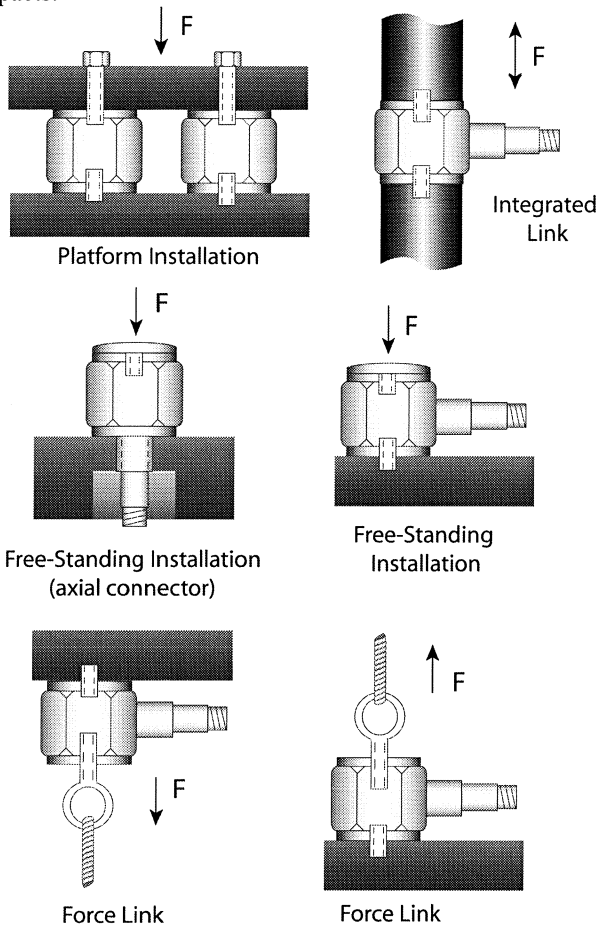

Figure 3 - Series 218 Charge Mode General Purpose Sensor

GENERAL PURPOSE - AXIAL

Model 218A11 Axial Sensor provides performance and possesses specifications similar to the Model 218C Sensor. Model 218A11 is designed primarily to measure compression and impact from 10 to 5,000 lbs (44.48 N to 22.24 kN). Tension forces can be measured to 500 lbs (2.224 kN). The 10-32 axial electrical connector orientation associated with these sensors makes them ideal for installations where radial space is restricted or where physical connector damage may occur due to the nature of the specific application. The M7 x 0.75-6g mounting threads may be installed directly into a test structure so that the 10-32 electrical connector exits from the opposite side of the mounting fixture to prevent potential damage. This version also uses the Model 084A03 cap for impact measurements.

LINKS

Series 231B to 237B Charge Mode Link Sensors are designed for measuring compression and tension forces from 10 lbs. to 50,000 lbs (44.48 N to 222.4 kN), and tension forces from 10 lbs. to 30,000 lbs (44.48 N to 133.4 kN). A link consists of a

standard PCB ring sensor, preloaded between two hex end nuts. All hex nuts are internally threaded for mounting ease. External preloads are not required with these sensors, as they are internally preloaded during manufacture. Loosening or tightening of the hex nuts will change the internal preload of the sensor. At this point, the sensitivity provided on the calibration certificate will no longer represent that of the sensor. If this should occur, refer to the service and repair document for proper information.

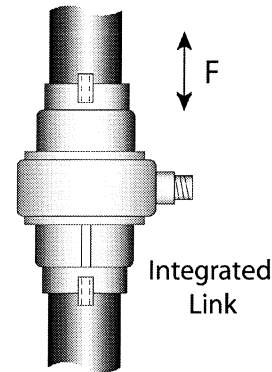

Figure 4 - Series 231B to 237B Charge Mode Link Sensor

THREE COMPONENT RINGS

3-Component force sensors are capable of simultaneously measuring force in three orthogonal directions (X, Y, and Z). They contain three sets of quartz plates that are stacked in a preloaded arrangement. Each set responds to the vector component of applied force acting along its sensitive axis. 3-Component force sensors must be externally preloaded for optimum performance and linear operation. Versions are available with ranges up to 10,000 lbs (44.48 kN) in the Z-axis (perpendicular to the top surface), and up to 4,000 lb (18 kN) in the X and Y (shear) axes.

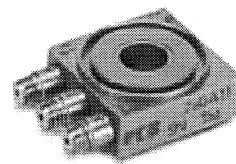

Figure 5 - Charge Mode 3-Component Force Sensor

PCB also offers 3-component force sensors with reversed X and Y (shear) axes, Models 260A31, A32, and A33 which accommodate installations with this particular need. The performance and physical characteristics of these models are the same as 260A11, A12, and A13 respectively. These models are primarily used for applications where multiple 3-component sensors need to be summed but the installation does not allow for the connectors on all sensors to be oriented in the same direction.

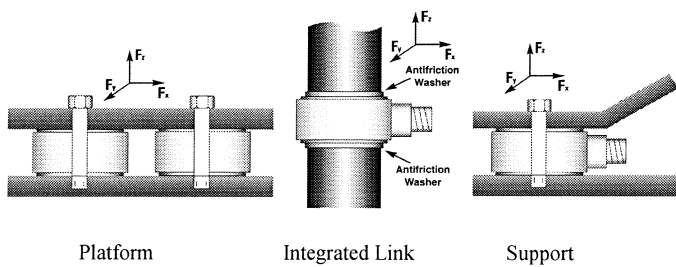

Figure 6 - Series 260A11 to 260A33 Charge Mode 3-Component Force Sensor

3.0 INSTALLATION

Refer to the Installation Drawing supplied with this manual for specific outline dimensions and installation details for your particular model. The specification is also included to provide details of the sensor's characteristic properties. It is important that the surface to which each sensor is mounted be perfectly flat to avoid flexing of the base, which could affect sensor sensitivity and result in erroneous data (see **Figure 7**). A good mating surface may be obtained by lapping, turning, spot facing, or surface grinding. Surface flatness should be held to within 0.001in (0.03mm) TIR over the entire mating surface. The protective cap should remain on the connector during installation to prevent contamination or damage.

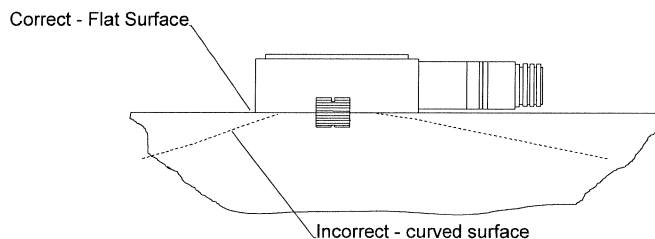

Figure 7 - Force Sensor Installation

A light coating of silicon grease (DC-4 or equivalent) on the mating surface enhances the coupling between the mounting base and mounting surface and provides the best high-frequency response.

Connect one end of the coaxial cable to the sensor connector and the other end to the charge amplifier input connector. Make sure to tighten the cable connector to the sensor. **DO NOT** spin the sensor onto the cable, as this fatigues the cable's center pin, resulting in a shorted signal and a damaged cable.

For installation in dirty, humid, or rugged environments, it is suggested that the connection be shielded against dust or moisture with shrink tubing or other protective material. Strain relieving the cable/sensor connection can also prolong cable life. Mounting cables to a test structure with tape, clamps, or adhesives minimizes cable whip. (See **Figure 8** for

an example of a sensor installation with a securely fastened cable.)

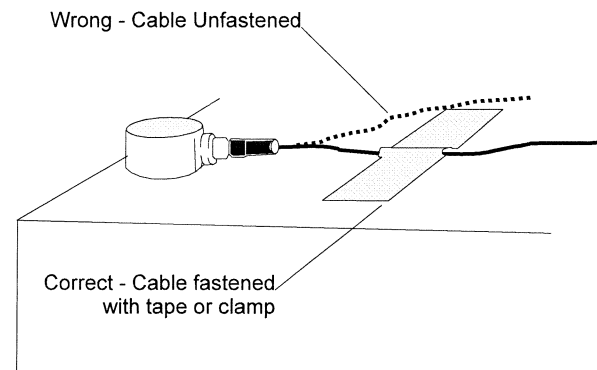

Figure 8 - Cable Strain Relief

FORCE RING INSTALLATION

The sensor is mounted using the supplied mounting stud and pilot bushing. The supplied beryllium copper stud is elastic so it allows force transmission to the sensor while holding the sensor in place. The pilot bushing centers the sensor about the mounting stud. After installing the mounting stud in the lower of the two surfaces, the pilot bushing is threaded over the mounting stud. The sensor is then placed over the stud and pilot bushing combination. The pilot bushing should fit loosely inside of the sensor inner diameter, holding it in place.

Properly machined holes for the mounting stud will ensure proper vertical orientation of the sensor. The upper surface should be installed and tightened onto the mounting stud. When installing the sensor as an integrated member, it is recommended that the supplied antifriction washers be used to eliminate the possibility of damage to the sensing surface of the sensor. This type of damage may occur when imperfections in the mounting surface grind against the sensor surface while the mounting surfaces are being twisted during installation. Refer to the installation drawing for additional mounting details.

PRELOAD REQUIREMENTS FOR FORCE RING AND 3-COMPONENT FORCE SENSORS

PCB Force Rings (Models 211B through 217B) and 3-Component Force Sensors (Models 260A11 through 260A33) are generally installed between two parts of a test structure, as shown in **Figure 6**, with the supplied elastic beryllium-copper stud or customer-supplied bolt. During installation, the sensor should be pre-loaded to the amount specified on the specification sheet using the supplied elastic beryllium-copper stud or customer-supplied bolt. Preloading in this arrangement ensures that the sensor will perform as calibrated and have good output linearity at the sensor's lower operating range.

The stud or bolt holds the structure together and applies preload to the force ring as shown in **Figure 9**. In the typical installation, shown on the left in **Figure 9**, part of the force between the two structures is shunted through the mounting stud. The amount of force shunted may be up to 5% of the total force for the beryllium-copper stud supplied with the sensor and up to 50% for steel studs. This typical installation setup is used by PCB during standard calibrations.

Another non-typical installation is shown on the right side of **Figure 9**. In this installation, the stud or bolt used to apply the preload does not shunt part of the applied force. The plate on top of the sensor has a clearance hole that the stud or bolt passes through. In this installation, the stud or bolt is not directly connected to the top plate by its threads, as it is in the typical installation, so it does not shunt any force.

NOTE: If any of the following conditions apply to the preloading of the force ring in the actual application, the sensitivity and linearity performance of the sensor will not match the standard PCB calibration values.

8.0 Use of a stud or bolt other than the supplied beryllium-copper stud.

9.0 Use of no stud or bolt.

10.0 Use of an amount of preload other than the recommended amount.

11.0 Use of the non-typical installation setup shown below.

12.0 In these cases, please contact a Force/Torque Division application engineer to discuss your special calibration requirements.

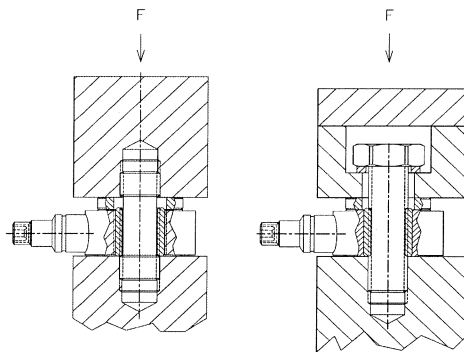

Typical Installation

Non-Typical Installation

Figure 9 - Force Ring Sensor Installations

PCB in-house calibration procedure requires the installation of a force ring with BeCu stud in the typical installation, in series with a NIST traceable reference sensor. Generally, a preload of 20% (full scale operating range of the force ring) is applied before recording of measurement data. Contact a PCB application specialist for proper preload requirements. Allow

the static component of the signal to discharge before calibration.

To apply pre-load, the sensor must be installed between two surfaces. A compressive force must be applied through the center axis to create the necessary pre-load. A signal that is produced by a static load should be zeroed prior to the taking a measurement. Refer to corresponding charge amplifier manual for zeroing instructions. The through-hole mounting supports platform, integrated link, and support style installations using either a through bolt or supplied stud. When installing charge mode ring and 3-component type sensors, a PCB charge amplifier should be set in long time constant mode. Likewise, a PCB signal conditioner with DC coupling capabilities is recommended if a charge mode sensor is used with an external charge converter or source follower. A DC-coupled signal conditioner will provide a longer system discharge time constant, which will result in slower signal decay. When used with a DVM or similar readout device, the installer can monitor the sensor output voltage directly for correct preloading.

3-component force sensors must be preloaded to achieve proper operation, particularly for the shear x-, and y-axis. When preloading, monitor the output from the Z-axis connector. The recommended applied preload for 3-component force sensors is 10 times their x-axis or y-axis measurement range. This preload provides the sensing crystals with the compressive loading required to achieve an output in response to shear direction input forces. When using an in-line charge converter or source follower, some models require this to be accomplished in steps, not to exceed the usable voltage. To prevent "clipping" of the signal, increments should not exceed 10 VDC.

As with force rings, the sensitivity achieved from a 3-component force sensor is dependent upon the applied preload and the elasticity characteristics of the mounting bolt or stud used. If the unit is to be installed with a stud or bolt other than the supplied elastic beryllium copper stud, a calibration using the actual mounting hardware must be performed. Errors in sensitivity of up to 50% can result by utilizing studs or bolts of different materials.

Force Ring Models	Pre-Load (lbs)
211B	1,000
212B	2,000
213B	4,000
214B	8,000
215B	12,000
216B	16,000
217B	33,750
3-Component Models	
260A11	5,000
260A12	10,000
260A13	40,000

Figure 10 - Preload Requirements for Standard Models

4.0 OPERATION

APPLICATION OF A FORCE

For best results, the applied force should be distributed evenly over the contact surface of the sensor. Care should be taken to limit the bending moment induced into the sensor. This is accomplished by applying a force to the sensor as close as possible to the center of the sensor. It will not be practical to limit this induced bending moment if the sensor is used singularly and if it is mounted beneath a thick plate. In this case, it may be necessary to use an arrangement of two to four sensors in a measuring platform. Independent sensor output can be monitored or the sensors can be connected electrically in parallel to measure the resulting summed forces when used in a plate type arrangement.

TYPICAL CHARGE SYSTEM CONFIGURATION

Charge Mode Sensors require an external charge amplifier for impedance conversion. The charge amplifier should be placed as close to the sensor as possible to avoid contamination and minimize triboelectric (cable) noise. The rubbing of the strands within the cable that creates a static charge causes this triboelectric noise. It is important to keep the cable well strain relieved during testing to help reduce noise.

Each cable also has a capacitance-per-length specification, measured in Pico farads. This additional capacitance must be taken into account when determining total system capacitance. It is important to keep the low-noise cable length between the sensor and charge amplifier, or charge converter, as short as possible.

During applications in which the charge amplifier cannot be placed near the sensor, an external charge converter or source follower may be substituted. PCB Series 402 (non-signal inverting) and Series 422 (signal inverting) miniature charge amplifiers can be installed in-line with the charge sensor. These charge converters convert the sensor's high impedance charge signal to a low-impedance voltage that is transmitted

across long cables to the signal conditioner and readout. The small size of these converters allows signal conversion in remote or restricted areas.

Operation requires the connection of the force sensor first to a charge amplifier or charge converter. PCB Series 003 Low-Noise Cable should be incorporated at this location. Tighten the coaxial cable to the sensor by hand to ensure good electrical contact. **DO NOT** spin the sensor onto the mating cable connector, as this fatigues the cable's center pin, resulting in a shorted signal and a damaged cable. If operating directly to a charge amplifier, the signal may then be routed from a charge amplifier to the readout devices. If an in-line charge converter is used (Series 402 or 422), the signal may be routed from the converter to an ICP® constant-current signal conditioner, such as Series 440, 480, 482, or 484. From the signal conditioner, readout instruments may be directly connected. It is recommended to use a source follower as close as possible to the charge output sensor. Driving long cables in a charge mode system is not suggested due to the induced noise.

8.0 POLARITY

Compressive forces upon a charge mode force sensor produce a negative output. Tensile forces produce a positive output. Most charge amplifiers invert the signal from piezoelectric sensors. Sensors with reversed polarity are available upon request.

9.0 LOW-FREQUENCY MONITORING

Low frequency response of high-impedance systems is determined by the electrical characteristics of the charge amplifier. Consult the charge amplifier specifications for these characteristics.

PCB charge amplifiers have settings for short, medium, and long time constants. The short time constant is provided for use during repetitive, or transient, dynamic applications. The medium time constant is designed for slightly longer applications and some calibrations. The long time constant is provided for even longer quasi-static applications, as well as calibrations. The low frequency response of the application depends on the input resistance of the sensing system, namely the sensor cable, amplifier and readout device.

10.0 DISCHARGE TIME CONSTANT

The discharge time constant represents the decay rate of an input signal. One DTC represents the amount of time taken for the signal to decay to 37% of the initial peak value. As illustrated in **Figure 11**, this is an exponential decay. Approximately five DTC intervals are needed for a peak signal to naturally decay back to zero.

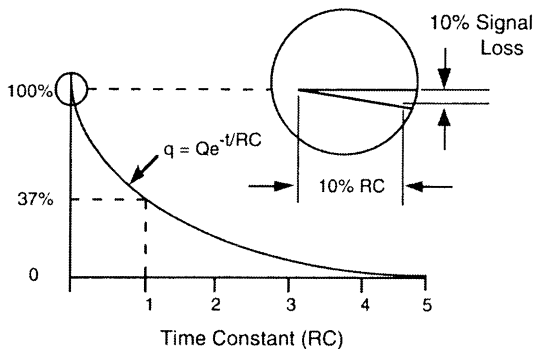

Figure 11 - Characteristic Discharge Time Constant Curve

The rule of thumb for signal discharge, as outlined in **Figure 12**, is this: for the first 10% of the DTC, the signal lost is approximately proportional to the time elapsed.

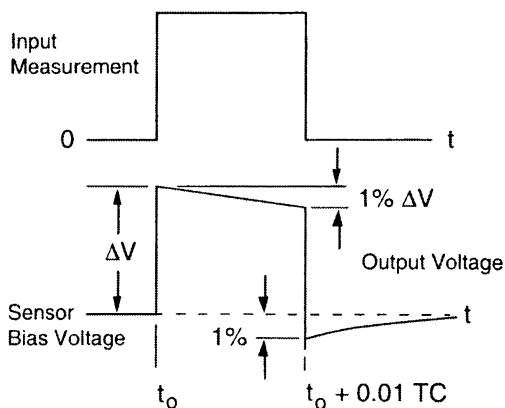

Figure 12 - Step Function Response

TIME CONSTANT DETERMINATION IN CHARGE MODE SYSTEMS

Discharge Time Constant (DTC) of a charge mode system is determined by multiplying the desired operating range setting of the charge amplifier by setting of the amplifier DTC switch, located on the charge amplifier (refer to specific charge amplifier for the DTC settings). Many PCB charge amplifiers have short, medium, and long DTC settings. See the operating manual of the specific charge amplifier in question for DTC position factors.

It is possible to measure quasi-static events with piezoelectric sensors. Over the first 10% of the DTC, signal decay and accuracy represent a one-to-one relationship. Over 2% of the DTC, a 2% signal loss has occurred. Over 7%, a 7% signal loss has occurred, and so on. For 1% measurement accuracy, it is recommended that the reading be taken within the first 1% of the DTC. If it is possible to avoid AC coupling somewhere in the sensing system, try to keep the coupling time constant at least an order of magnitude longer than the DTC of the force sensor. This avoids compromising the sensor DTC.

8.0 CALIBRATION

A NIST (National Institute of Standards and Technology) traceable calibration graph is supplied with each force sensor certifying its charge sensitivity (pc/lb). Calibration procedures follow accepted guidelines as recommended by ANSI (American National Standards Institute), ISA (Instrument Society of America), and ISO (International Organization for Standardization). These standards provide the establishment and management of complete calibration systems, thus controlling the accuracy of a sensor's specifications by controlling measuring and test equipment accuracy. PCB is A2LA accredited for technical competence in the field of calibration, meeting the requirements of ISO/IEC 17025-1999 and ANSI/NCSL 2540-1-1994.

The charge mode force sensor, low-noise cable and 402 Source Follower may be calibrated as a system (providing mV/lb output) upon request. The sensor may be statically calibrated by using either a proving ring or standard load cells.

9.0 TROUBLESHOOTING

PROBLEM: **No Output**

POSSIBLE CAUSE:

Faulty or no cable connection
Improper time constant (TC) switch setting
Low sensor capacitance
Faulty charge amp
Low sensor insulation (less than 1×10^{12})

SOLUTION:

Properly attach or replace cable
Ensure switch is set properly (SHORT/ MED/ LONG)
Call factory for service
Call factory for service
Call factory for service

PROBLEM: **Intermittent Output**

POSSIBLE CAUSE:

Faulty cable connection
Improper charge amp setting
Intermittent sensor

SOLUTION:

Properly attach or replace cable
Set charge amp to proper setting
Call factory for service

PROBLEM: **Output Drift**

POSSIBLE CAUSE:

Faulty cable
Rapid Temperature Change
Low charge amp insulation
Low sensor insulation
Faulty sensor

SOLUTION:

Replace cable
Allow sensor to adapt to environment
Call factory for service
Call factory for service
Call factory for service

PROBLEM: **Improper Sensor Sensitivity**

POSSIBLE CAUSE:

Improper XDCR sensitivity dial setting
Faulty sensor

SOLUTION:

Ensure dial is adjusted and locked into proper setting
Call factory for service

10.0 MAINTENANCE

The sensor connector must be kept clean, especially if it is operating in a dusty and/or wet environment. Because the force sensor is of welded construction, it should be returned to the factory for servicing in the event of serious malfunction.

Observe the following precautions in using the sensor:

- a. Do not exceed the maximum load levels for the force sensor (see specification sheet).
- b. Do not subject the sensor to temperatures exceeding that of the specification, normally 400°F (204°C).
- c. When mounting the force sensor, observe installation procedures detailed in Section 3.0 and as outlined on the specific sensor Installation Drawing to avoid overtorquing when mounting.
- d. *Avoid metal-to-metal impacts* during applications, which can produce a high-frequency ringing. Electrical low-pass filtering or a damping material can help reduce such effects.
- e. *Do not spin the sensor onto the cable.* This may fatigue the cable center pin, causing cable damage. Always insert the cable pin into the sensor and tighten the knurled cable nut to the sensor.

ICP® is a registered trademark of PCB Piezotronics

MANUAL NUMBER: 18219

MANUAL REVISION: C

ECN NUMBER: 22517

1206

APPLICATION		
NEXT ASS'Y	USED ON	VAR

REVISIONS				
REV	DESCRIPTION	ECN	DATE	APP'D

Ø.520(Ø13.21) THRU HOLE

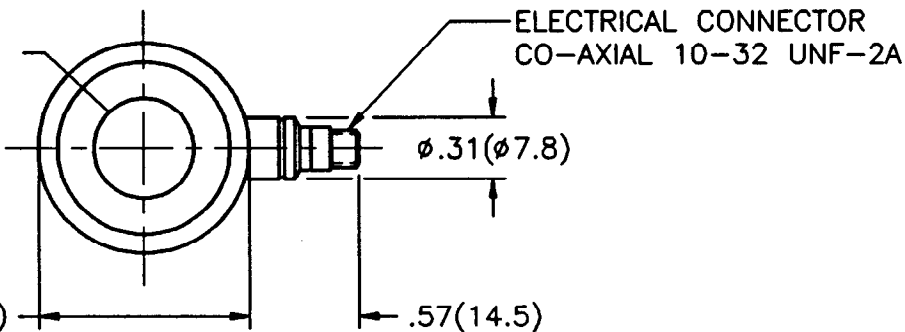

Ø1.100(Ø27.94)

ELECTRICAL CONNECTOR
CO-AXIAL 10-32 UNF-2A

MODEL 082B03
ANTI-FRICTION
WASHER (SUPPLIED)

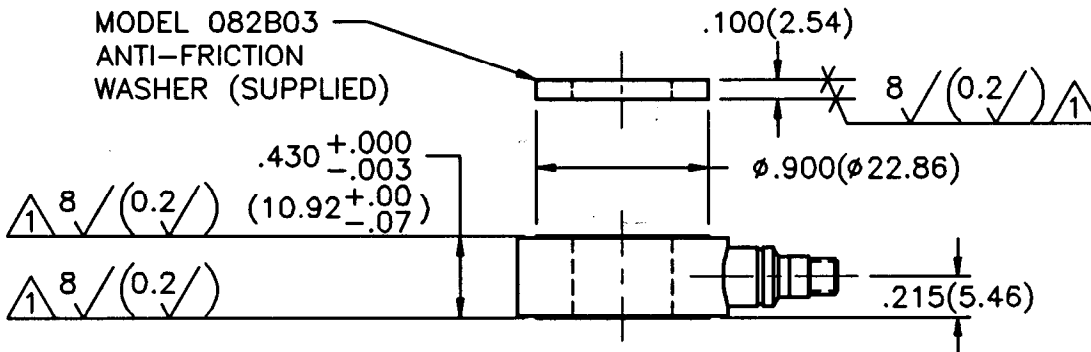

1/2 IN. THD BOLT
(NOT SUPPLIED)

MODEL 082B03
ANTI-FRICTION
WASHER

DRILL AND TAP $\triangle 3$
AS REQUIRED FOR
1/2 IN. THD. BOLT

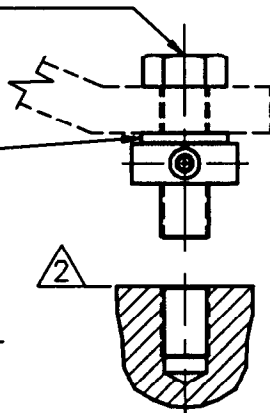

SCALE: .5X

TYP BOLT MOUNTING
INSTALLATION

MODEL 081A13 STUD
3/8-24 UNF-2A
TYP EACH END
(SUPPLIED)

MODEL 083B03
PILOT BUSHING
(SUPPLIED)

$\triangle 3$ DRILL Ø.332(Ø8.43)
X .400(10.16) ∇
TAP 3/8-24 UNF-2B
X .300(7.62) ∇ MIN.
PERFECT THD

1.10(27.9)

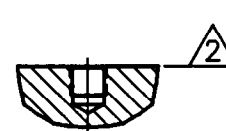

SCALE: .5X

TYP STUD MOUNTING
INSTALLATION

4.) SEE MANUAL FOR PRELOAD INSTRUCTIONS.

$\triangle 3$ DRILL PERPENDICULAR TO MOUNTING SURFACE WITHIN ± 1 DEGREE.

$\triangle 2$ MOUNTING SURFACE UNDER FORCE RING MUST BE FLAT TO WITHIN .001(.03) WITH AT LEAST $63\sqrt{(1.6/\)}$.

$\triangle 1$ THESE SURFACES FLAT TO WITHIN .001(.03) TIR.

UNLESS SPECIFIED TOLERANCES

DIMENSIONS IN INCHES
DECIMALS XX $\pm .01$
XXX $\pm .005$
ANGLES ± 2 DEGREES

DIMENSIONS IN MILLIMETERS
(IN PARENTHESES)
DECIMALS X ± 0.3
XX ± 0.13
ANGLES ± 2 DEGREES

FILLETS AND RADII .003 - .005 (0.07 - 0.13)

DRAWN	ZAB	5/16/94	MFG	RJA	5/16/94
CHK'D	DM	5/16/94	ENGR	SGC	5/16/94
APP'D	HS	5/16/94	Sales	SGC	5/16/94
TITLE	INSTALLATION DRAWING				
	MODEL 213B				
	FORCE RING				

PCB PIEZOTRONICS, INC.
3425 WALDEN AVE. DEPEW, NEW YORK 14043
PHONE: (716) 684-0001

CODE
IDENT. NO.
52681

DWG. NO.

1206

SCALE: FULL SHEET 1 OF 1